

2019



Fournitures
scolaires & de bureau
loisirs créatifs

Wonday[®]

creative tools for school and business



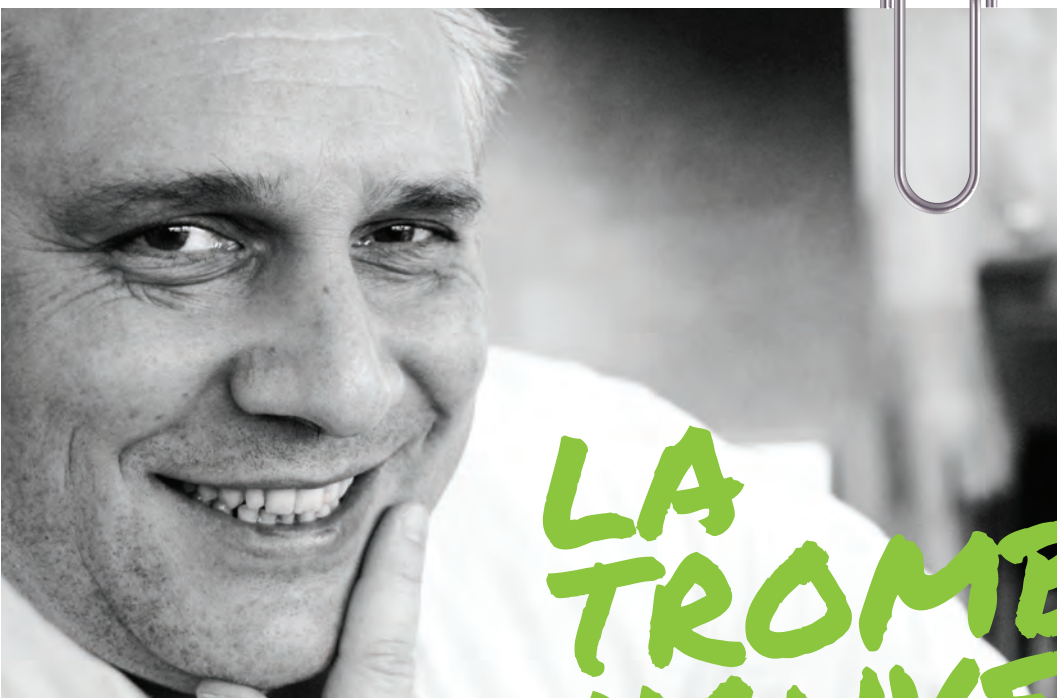

LA TROMBONE NOUVELLE !

Notre nouvelle marque s'affiche dans nos catalogues 2019 !

Elle s'appelle **Wonday**.

Identifiable, pop et acidulée, elle est calibrée pour séduire le grand public.

Son ambition ? Devenir la marque préférée des consommateurs et une référence européenne sur notre marché.

Née du rapprochement de JPC Créations et Safetool, cette marque est l'acte fondateur de la fusion de ces deux sociétés à horizon 2021.

Aujourd'hui nous vous présentons 700 produits référencés **Wonday**.

Ceux-ci cohabitent avec nos marques propres et celles de nos partenaires. D'ici 2021, les gammes vont s'étoffer et s'harmoniser, de nouveaux produits toujours plus malins vont naître ainsi que des outils marketing et un site internet dédié.

Notre objectif est de mieux vous servir en mettant en place une organisation plus courte et plus fluide afin de faciliter nos échanges. Nous ferons tout cela sérieusement sans jamais nous prendre au sérieux.

Wonday résonne pour nous comme une promesse à tenir : la volonté d'être encore plus proches de vous, nos clients et partenaires de toujours !

Cyrille Cargnelutti, *Président*



Wonday

MANIFESTE
WONDAY



PARCE QUE NOUS CROYONS QU'UN TROMBONE, AUSSI PETIT SOIT-IL,
PEUT CHANGER LE COURS D'UNE JOURNÉE,
NOUS NOUS PLIONS EN HUIT POUR TRANSFORMER
L'ORDINAIRE EN EXTRAORDINAIRE.

PARCE QUE NOUS CROYONS QUE LA MOROSITÉ
AU BUREAU OU À L'ÉCOLE
N'EST PAS UNE FATALITÉ,
NOUS CUMULONS LES ATTENTIONS
POUR CHASSER LES NUAGES
ET VOUS OFFRIR DES COULEURS.

PARCE QUE NOUS CROYONS QUE SOURIRE ENSEMBLE
RESTE LE MEILLEUR MOYEN D'ENCHANTER LE QUOTIDIEN,
NOUS TRAVAILLONS SÉRIEUSEMENT
SANS JAMAIS NOUS PRENDRE AU SÉRIEUX.

NOUS NOUS ENGAGEONS À FAIRE DE CHAQUE JOUR
UN JOUR MEILLEUR



Wonday

NOUVELLE
MARQUE

NOUVEAUX
PRODUITS

NOUVEAUX
PACKAGINGS

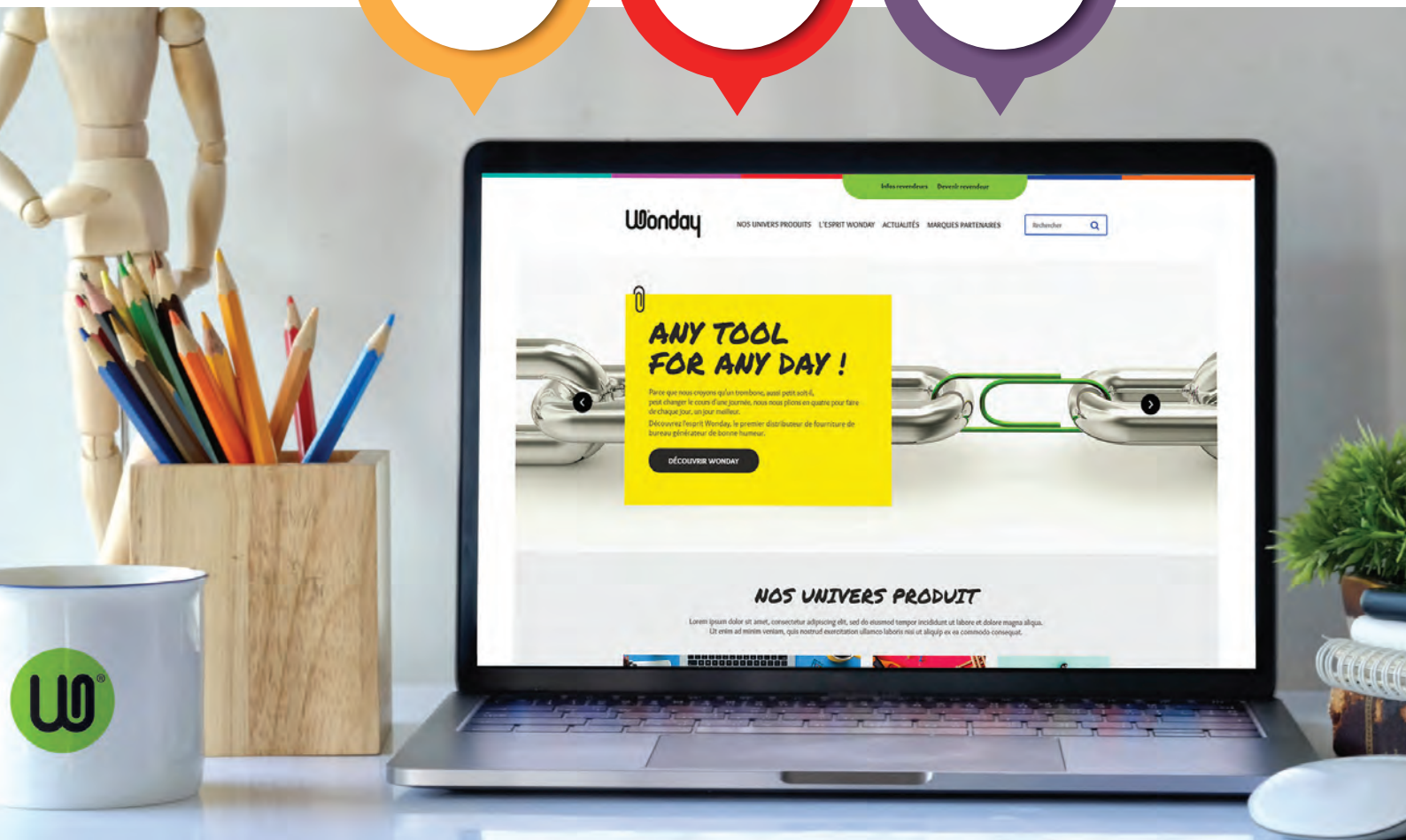

Wonday, la marque complice de votre quotidien !

Et si un petit trombone savait votre journée? Ce petit objet populaire et universel est l'icône de la marque Wonday. Il symbolise la simplicité, la souplesse et la créativité... comme nous!

Il vous garantit de passer une « trombone journée » au bureau, à l'école et à la maison.

Wonday est née pour égayer nos journées et chasser la morosité du quotidien !

Les produits de la marque Wonday appartiennent à une même famille et ont un même ADN. Ils ont été créés pour séduire le grand public et répondre aux attentes des consommateurs. Depuis près de 70 ans, nos équipes sont attentives aux besoins du marché et sont en constante recherche de nouveautés. Nos emballages sont étudiés, réfléchis et harmonisés (design/graphisme/respect de l'environnement). **So Wonday!**



www.wonday.com





UN MONDE D'INVENTION

Depuis 1993, **JPC CREATIONS** oeuvre sur le marché de la papeterie pour proposer des produits innovants alliant design et fonctionnalité. Toujours à l'écoute de nos clients et des besoins du marché, nous faisons évoluer notre offre produit et nos packagings au fil des années.

Unaniment reconnus pour notre offre scolaire, nous avons su nous diversifier et créer les bons partenariats afin d'offrir une véritable gamme de produits pour le bureau qui nous permet de travailler avec les grands acteurs de ce secteur.

Cette profondeur de gamme couplée à notre service logistique permettant de livrer les petits comme les gros volumes font de JPC un partenaire incontournable. Véritable spécialiste des univers scolaires, bureaux et loisirs créatifs, nous travaillons aussi bien avec les détaillants, les centrales d'achats que les grossistes, les fournisseuristes, etc.

Comment lire nos tableaux

Modèle	Réf.	Conditionnement	UV	PCB
Model	Ref.	Packing		
 00 cm	000000 000000	Vrac / Bulk Pegboardable	20 25	320 300

Photos et coloris non contractuels

UV : Unité de vente
/ Minimum of order

PCB : Par combien / Outer
Conditionnement supérieur



Pegboardable :
Peut être présenté sur broche.



Vrac / Bulk :
Article en boîte ou sachet
qui ne peut pas être suspendu.

Repères visuels présents sur notre catalogue :



Catalogue imprimé
sur du papier PEFC



Fabrication Française
/ Made in France



Fabrication Européenne
/ Made in EU



Articles disponibles sous la nouvelle marque Wonday
Products available under new Wonday brand



Nouveautés
New items

Le développement durable, environnemental et social. Plus qu'une mode, un état d'esprit.

Le développement durable, chez **JPC CREATIONS**, se traduit depuis des années par des actions concrètes dans le souci de préserver l'avenir. Du choix de nouveaux fournisseurs, Européens dès que cela est possible, à l'utilisation de matériaux responsables pour la fabrication de nos produits ; nous intégrons le respect de l'environnement et l'aspect social dans tout notre processus de développement.

Pour chaque création de produit, nous vérifions le détail des matériaux utilisés, les certifications que possède l'usine et les rapports d'audit qu'elle a pu passer, de manière à intégrer ces données dans notre processus de choix. Il nous arrive de renoncer à une nouveauté si nous considérons qu'elle ne respecte pas nos exigences ou de privilégier un partenaire plutôt qu'un autre quand il utilise des matériaux non polluants et qu'il fait travailler ses salariés dans de bonnes conditions.

Pour faire suite à la collecte de ces documents et leur contrôle par notre service qualité, nous visitons régulièrement les sites de production pour vérifier la véracité des informations transmises. Nous avons d'ailleurs constaté que les conditions de travail s'améliorent peu à peu sur les sites avec lesquels nous travaillons.

En complément de cette démarche, nous faisons évoluer nos emballages. Nous offrons une gamme de produits en boîte présentoir « type vrac » toujours plus large et réduisons la taille de nos cartes blister pour diminuer leur consommation en carton et plastique.

Nous oeuvrons au quotidien pour améliorer notre offre globale tout en gardant le niveau de qualité auquel nos clients sont habitués.

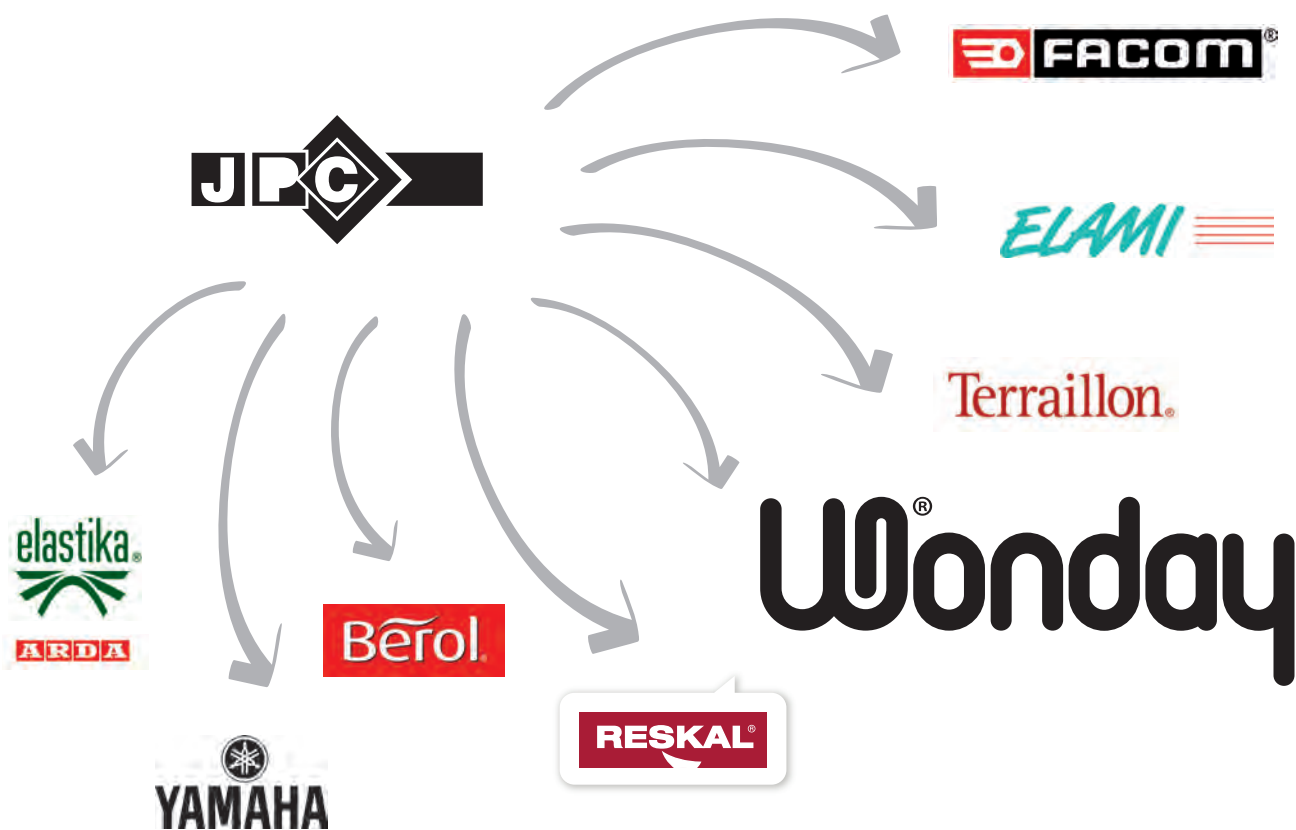

SOMMAIRE / CONTENTS

8 à 27 DÉCOUPER-TAILLER / CUTTING - SHARPENING

28 à 45 AGRAFER-PERFORER-ASSEMBLER / STAPLING-PUNCHING-ASSEMBLING

46 à 47 COLLER-CORRIGER / STICKING-CORRECTING

48 à 65 TRACER-MESURER / DRAWING-MEASURING

66 à 69 COMMUNIQUER / COMMUNICATING

70 à 88 ORGANISER-OBSERVER / ORGANISING-WATCHING

89 à 95 SERVICES GÉNÉRAUX / GENERAL SERVICES

96 à 99 DECOUVRIR / DISCOVERING

100 à 130 EFFACER-ENSEIGNER-PEINDRE / ERASING-TEACHING-PAINTING

131 à 140 LOISIRS CRÉATIFS / CRAFT

141 à 144 INDEX / INDEX

Index numérique
et alphabétique
p. 141 à 144

■ CISEAUX BUREAU & MAISON / OFFICE AND HOME SCISSORS

Initial

Bi-matière
Bi-material
Lames inox
Stainless steel blades
Bouts pointus
Pointed tips

17 cm / 21 cm

Anneaux asymétriques
Asymmetrical handles

15 cm / 19 cm

Anneaux symétriques
Symmetrical handles



FCI150182



FCI170182



FCI190182



FCI210182

Modèle	Réf.	Conditionnement	UV	PCB
Model	Ref.	Packing		
15 cm	FCI150182	Pegboardable	12	120
17 cm	FCI170182	Pegboardable	12	120
19 cm	FCI190182	Pegboardable	12	120
21 cm	FCI210182	Pegboardable	12	120



* Vendu exclusivement
en présentoir.
Available in display only.

Réf. 000042

Mini Pack « INITIAL » *

Ciseaux à anneaux symétriques

6 ciseaux « INITIAL » 15 cm Réf. 261152

6 ciseaux « INITIAL » 19 cm Réf. 261192

Ciseaux à anneaux asymétriques

6 ciseaux « INITIAL » 17 cm Réf. 261172

6 ciseaux « INITIAL » 21 cm Réf. 261212



Evolut

- Anneaux bi-matière
Bi-material handles
- Lames inox
Stainless steel blades
- Bouts pointus
Pointed tips

Modèle Model	Réf. Ref.	Conditionnement Packing	UV	PCB
17 cm	FCI170382	Pegboardable	10	120
21 cm	FCI210482	Pegboardable	10	120



FCI170382



FCI210482

Tribal

- Anneaux bi-matière
Bi-material handles
- Lames inox
Stainless steel blades
- Bouts pointus
Pointed tips

Modèle Model	Réf. Ref.	Conditionnement Packing	UV	PCB
16 cm	FCI160082	Pegboardable	12	120
21 cm	FCI210282	Pegboardable	12	120



FCI160082



FCI210282

Solar

- Anneaux ergonomiques
Ergonomic handles
- Lames inox haute qualité
High quality stainless steel blades
- Bouts pointus
Pointed tips

Modèle Model	Réf. Ref.	Conditionnement Packing	UV	PCB
17 cm	FCI170562	Pegboardable	12	120
21 cm	FCI210862	Pegboardable	12	120



FCI170562



FCI210862

Robust

Coupe sans effort carton, ficelle...
Easily cut thick materials such as cardboard, rope...

Lame crantée inox traité

Processed stainless steel blade with serrated edge



Lame crantée



FC1170662

Modèle	Réf.	Conditionnement	UV	PCB
Model	Ref.	Packing		
17 cm	FC1170662	Pegboardable	12	120



Ciseaux à cranter

Pinking shears

Pour travaux manuels
Pinking shears for handicraft use

Coupent le tissu

Cut fabric

Avec bille de rattrapage

With correction ball

Lames inox

Stainless steel blades

Anneaux bi-matière

Bi-material handles



FC1230082



FC1230082

Modèle	Réf.	Conditionnement	UV	PCB
Model	Ref.	Packing		
Bi-matière / Bi-material				
23 cm	FC1230082	Boîte / Box	1	72
14 dents				



Ergo 2

Anneaux ergonomiques

Ergonomic handles

Spécial "gros travaux"

Special heavy duty

Lame crantée

Blade with serrated edge

Lames inox

Stainless steel blades



Lame crantée



21 cm

23 cm

25 cm



289214

Modèle	Réf.	Conditionnement	UV	PCB
Model	Ref.	Packing		
21 cm	289214	Pegboardable	12	120
23 cm	289234	Pegboardable	12	120
25 cm	289254	Pegboardable	12	120





Electron

Pratique et résistant
Practical and hardwearing

Lames inox

Stainless steel blades

Anneaux symétriques

Symétrical handles



FCI171061



Lames spécialement
inversées pour coupe
à gauche

Left-handed scissors
(reversed blades)



Modèle	Réf.	Conditionnement	UV	PCB
Model	Ref.	Packing		
BOUTS POINTUS / POINTED TIPS ■				
17 cm	FCI170861	Vrac / Bulk	12	120
	FCI170962	Pegboardable	12	120
21 cm	FCI211061	Vrac / Bulk	12	120
	FCI211162	Pegboardable	12	120
BOUTS ROUNDS / ROUNDED TIPS				
17 cm	■ FCI171061	Vrac / Bulk	12	120
	■ FCI171162	Pegboardable	12	120
ELECTRON SPECIAL GAUCHER / LEFTHANDED SCISSORS				
17,5 cm	■ FCI171252	Pegboardable	12	120



FCI170962



FCI171252

Tout usage au bureau et à la maison

Home and office multipurpose scissors

Anneaux décentrés par rapport aux lames
pour une découpe bien à plat

Perfect flat cut with their asymmetric handles

Lames inox

Stainless steel blades

Anneaux asymétriques

Asymétrical handles



FCI211261



Lames spécialement
inversées pour coupe
à gauche

Left-handed scissors
(reversed blades)



FCI211452

Modèle	Réf.	Conditionnement	UV	PCB
Model	Ref.	Packing		
21 cm	■ FCI211261	Vrac / Bulk	12	120
	■ FCI211362	Pegboardable	12	120
21 cm	■ FCI211452	Pegboardable	12	120



The First

Anneaux asymétriques

Asymmetrical handles

Lames inox

Stainless steel blades



FCI210961



Modèle	Réf.	Conditionnement	UV	PCB
Model	Ref.	Packing		
17 cm	■ FCI170761	Vrac / Bulk	12	120
21 cm	■ FCI210961	Vrac / Bulk	12	120

Ciseaux Ambi'nox / Ambi'nox scissors

Acier inoxydable
Stainless steel
Anneaux confort élastomères
Soft rubber grip handles



FCI171671



FCI171571

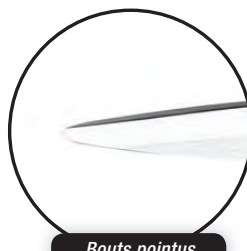

Bouts pointus



Bouts ronds



FCI171671



Anneaux confort



Modèle	Réf.	Conditionnement	UV	PCB
Model	Ref.	Packing		
INOX SATINÉ / SATIN STAINLESS STEEL				
BOUTS POINTUS / POINTED TIPS				
17 cm	FCI171671	Vrac / Bulk	12	144
20 cm	FCI200171	Vrac / Bulk	12	144
BOUTS ROUNDS / ROUNDED TIPS				
17 cm	FCI171571	Vrac / Bulk	12	144
20 cm	FCI200071	Vrac / Bulk	12	144

Lithographe / Lithograph

Précision
Accuracy
Montage sur vis
Screw-assembled
Inox brillant
Shiny stainless steel
Bouts pointus
Pointed tips



FCI171772



Modèle	Réf.	Conditionnement	UV	PCB
Model	Ref.	Packing		
INOX / STAINLESS STEEL				
17 cm	FCI171772	Pegboardable	12	120



■ CISEAUX ÉCOLE / SCHOOL SCISSORS

Caïd

- Support index
Forefinger place
- Gâchette anti-glisse
Softgrip part
- Lames inox
Stainless steel blades
- Bouts arrondis
Rounded tips



FCI130182



FCI150382



Lames spécialement inversées pour coupe à gauche
Left-handed scissors (reversed blades)



FCI130352

Modèle	Réf.	Conditionnement	UV	PCB
Model	Ref.	Packing		
13 cm	FCI130181	Vrac / Bulk	20	320
	FCI130182	Pegboardable	25	100
15 cm	268522	Vrac / Bulk	20	320
	FCI150382	Pegboardable	25	100

Modèle	Réf.	Conditionnement	UV	PCB
Model	Ref.	Packing		
Modèle Gaucher / Left-handed scissors				
13 cm	FCI130352	Pegboardable	12	120
15 cm	FCI150452	Pegboardable	12	240



Ciseaux CAÏD 13 cm
La paire Réf. **FCI130181**
Livré en boîte de 20 pces

Ciseaux CAÏD 15 cm
La paire Réf. **268522**
Livré en boîte de 20 pces



Réf. 026922
Box CAÏD Gaucher
10 ciseaux CAÏD Gaucher 13 cm Réf. **269322**
10 ciseaux CAÏD Gaucher 15 cm Réf. **269522**



Range Ciseaux CAÏD / CAÏD classpack



Modèle	Réf.	Conditionnement	UV	PCB
Model	Ref.	Packing		
20 pces Caïd 13 cm (Réf. FCI130181) + 5 pces Caïd 13 cm gaucher (Réf. FCI131751)				
FCI900283		Vrac / Bulk	1	16

FCI900283

Pour un rangement facile après la classe !
It is easier to tidy after class !



Enzo

Support index

Forefinger place

Lames inox

Stainless steel blades

Graduation au recto

Upper graduated blades

Bouts ronds

Rounded tips



FCI120061



FCI120162



Lames spécialement inversées pour coupe à gauche

Left-handed scissors (reversed blades)



FCI120251



FCI120352

Modèle	Réf.	Conditionnement	UV	PCB
Model	Ref.	Packing		
12 cm	FCI120061	Vrac / Bulk	20	120
	FCI120162	Pegboardable	25	100
15 cm	FCI150561	Vrac / Bulk	20	120
	FCI150662	Pegboardable	25	100

Modèle	Réf.	Conditionnement	UV	PCB
Model	Ref.	Packing		
Modèle Gaucher / Left-handed scissors				
12 cm	FCI120251	Vrac / Bulk	20	120
	FCI120352	Pegboardable	12	120

Range-ciseaux Enzo

Enzo classpack

Pour un rangement facile après la classe !
It is easier to tidy after class !

Modèle	Réf.	Conditionnement	UV	PCB
Model	Ref.	Packing		
20 pcs Enzo 12 cm (Réf. FCI120061) + 5 pcs Enzo 12 cm gaucher (Réf. FCI120251)				
	FCI900063	Vrac / Bulk	1	16



FCI900063

Range-ciseaux

Classpack

Range-ciseaux en plastique vide

Empty plastic classpack

25 emplacements

25 spaces

Pour un rangement facile après la classe,
tous nos ciseaux peuvent être présentés
dans leur range-ciseaux !

All our scissors can be bulk in our classpack :
It is easier to tidy after class.

Modèle	Réf.	Conditionnement	UV	PCB
Model	Ref.	Packing		
	FDB100061	Vrac / Bulk	1	20

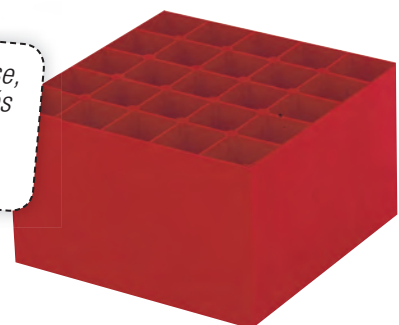

FDB100061



Tribal

Anneaux bi-matière
Bi-material handles

Intérieur des anneaux en matière souple pour un plus grand confort d'utilisation

Inside of handles in soft rubberized material for a more comfortable use

Bouts arrondis
Rounded tips



FCI130281



FCI130282



Modèle	Réf.	Conditionnement	UV	PCB
Model	Ref.	Packing		
13 cm	FCI130281	Vrac / Bulk	20	120
	FCI130282	Pegboardable	20	120

Initial

Support index
Forefinger place

Anneaux bi-matière asymétriques
Bi-material asymmetrical handles

Lames inox
Stainless steel blades

Bouts arrondis
Rounded tips



FCI130081



Modèle	Réf.	Conditionnement	UV	PCB
Model	Ref.	Packing		
13 cm	FCI130081	Vrac / Bulk	20	320



Ciseaux INITIAL 13 cm

La paire Réf. FCI130081
Livré en boîte de 20 pcs

Liberty

Anneaux bi-matière
Bi-material handles

Lames inox
Stainless steel blades

Bouts arrondis
Rounded tips

Modèle	Réf.	Conditionnement	UV	PCB
Model	Ref.	Packing		
13 cm	268304	Pegboardable	25	100



268304

Swing

Pour une découpe précise
For a precise cutting

Lames inox
Stainless steel blades

Bouts arrondis
Rounded tips



FC1130961



Couleurs assorties / Assorted colours

Modèle	Réf.	Conditionnement	UV	PCB
Model	Ref.	Packing		
13 cm	FC1130961	Vrac / Bulk	12	480

Cizoo

Blocage sécurité limitant
l'ouverture des lames
Safety autoblock system limiting
opening of blades

Lames inox
Stainless steel blades

Bouts arrondis
Rounded tips



268352

Modèle	Réf.	Conditionnement	UV	PCB
Model	Ref.	Packing		
13 cm	268352	Vrac / Bulk	20	120

Pti'futé

Son levier agit comme
un ressort sur les anneaux
et ouvre automatiquement
les lames : idéal pour apprendre
aux petits à découper...

Teach children how to cut with their spring
lever that automatically opens blades

Lames inox
Stainless steel blades

Bouts arrondis
Rounded tips



260212



260214

Modèle	Réf.	Conditionnement	UV	PCB
Model	Ref.	Packing		
12 cm	260212	Vrac / Bulk	20	120
	260214	Pegboardable	25	100



Maxou & Max

Les premiers ciseaux d'écolier

First school scissors

Lames inox

Stainless steel blades

Bouts ronds

Rounded tips



FCI100061



263100

Modèle	Réf.	Conditionnement	UV	PCB
Model	Ref.	Packing		
10 cm	FCI100061	Vrac / Bulk	12	480
11 cm	263100	Vrac / Bulk	20	120

Ecolier

Lames inox

Stainless steel blades

Bouts ronds

Rounded tips



FCI100161

Modèle	Réf.	Conditionnement	UV	PCB
Model	Ref.	Packing		
10 cm	FCI100161	Vrac / Bulk	20	480



Sécurité

Ciseaux sécurité

Safety scissors

Lames fibre de verre

Fibreglass blades

Ne coupent que le papier

Cut paper only

Ne coupent ni les cheveux,
ni les vêtements, ni la peau.

Do not cut hair, skin nor clothes.

A partir de 3 ans

From the age of 3.



FCI120462

Modèle	Réf.	Conditionnement	UV	PCB
Model	Ref.	Packing		
12 cm	FCI120462	Pegboardable	10	300



Ciseaux cranteurs

Craft scissors

Pour travaux manuels : pour
personnaliser et créer un décor !

For handicraft : to personalize and create sets !

Ne coupent que le papier

Cut paper only

Lames inox protégées

Stainless steel protected blades



ADE010063



275852

Modèle	Réf.	Conditionnement	UV	PCB
Model	Ref.	Packing		
Lot de ciseaux cranteurs - Motifs assortis				
Wallet of craft scissors / Assorted cutting shapes				
6 x 13 cm	ADE010063	Vrac / Bulk	1	36
6 x 16 cm	275102	Vrac / Bulk	1	36
12 x 16 cm	275852	Vrac / Bulk	1	24



TAILLE - CRAYONS / SHARPENERS

Plastique / Plastic



FTC100461

853042

FTC100563



Modèle	Réf.	Conditionnement	UV	PCB
Model	Ref.	Packing		
1 Usage / 1 Hole - Couleurs assorties / Assorted colours				
	FTC100461	Vrac / Bulk	24	144
2 Usages / 2 Holes				
	853042	Vrac / Bulk	24	1440
1 Usage Ø 17 mm = Spécial gros crayons / 1 Hole Ø 17 mm = for large pencils				
	FTC100563	Vrac / Bulk	10	1000

Métal / Metal



851102

851152

851202



851202

Modèle	Réf.	Conditionnement	UV	PCB
Model	Ref.	Packing		
1 Usage - Modèle Petit Violon / 1 Hole - Violin shape				
	851102	Vrac / Bulk	20	240
1 Usage - Modèle Uno JPC / 1 Hole - Classic shape				
	851152	Vrac / Bulk	20	240
2 Usages - Modèle Duo JPC / 2 Holes - Classic shape				
	851202	Vrac / Bulk	20	240

Laiton véritable / Real brass

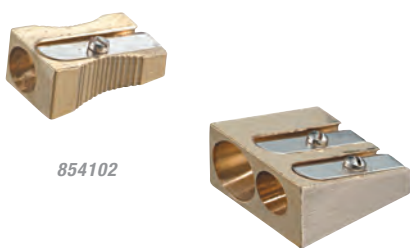

854102

854202



854108

Modèle	Réf.	Conditionnement	UV	PCB
Model	Ref.	Packing		
1 Usage - Modèle Petit Violon / 1 Hole - Violin shape				
	854102	Vrac / Bulk	10	100
	854108	Pegboardable	25	25
2 Usages - Modèle Classique / 2 Holes - Classic shape				
	854202	Vrac / Bulk	10	100
	854208	Pegboardable	25	25

Affûtoir / Wooden sharpener

En bois - pour crayon
Wooden sharpener for pencils
2 faces - longueur 20 cm
2 sides - length 20 cm



859012

Modèle	Réf.	Conditionnement	UV	PCB
Model	Ref.	Packing		
20 cm	859012	Vrac / Bulk	24	144





TAILLE - CRAYONS RÉSERVE 2 USAGES / 2-HOLE BIN SHARPENERS



« BOBSY » 2 usages

Taille-crayons à l'unité
Réf. 856202
 Livré en boîte de 24 pcs

BOBSY

Intérieur plastique
 Plastic inside
 2 usages
 2 holes

Extra plat
 Super flat



856202

Couleurs assorties / Assorted colours

Modèle Model	Réf. Ref.	Conditionnement Packing	UV	PCB
2 usages / 2 holes				
	856202	Vrac / Bulk	24	144



« TOM » 2 usages

Taille-crayons à l'unité
Réf. 856212
 Livré en boîte de 24 pcs

TOM

Intérieur plastique
 Plastic inside
 2 usages
 2 holes



856212

Couleurs assorties / Assorted colours

Modèle Model	Réf. Ref.	Conditionnement Packing	UV	PCB
2 usages / 2 holes				
	856212	Vrac / Bulk	24	144



« TANDEMO » 2 usages

Taille-crayons à l'unité
Réf. 856232
 Livré en boîte de 20 pcs

Tandemo

Intérieur plastique
 Plastic inside
 2 usages
 2 holes

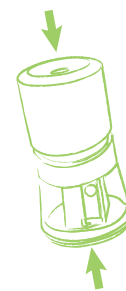

856232



Modèle Model	Réf. Ref.	Conditionnement Packing	UV	PCB
2 usages / 2 holes				
	856232	Vrac / Bulk	20	240

Taill'Liberty

SCOLAIRE

Intérieur métal
ou plastique

Metal or plastic inside

Réserve vissée

Screwed-on bin

Corps plastique

Plastic body

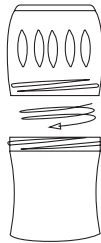

Intérieur plastique

Intérieur métal



FTC250461



FTC250371



Modèle	Réf.	Conditionnement	UV	PCB
Model	Ref.	Packing		
Intérieur TC Métal / Métal inside				
2 usages / 2 holes				
	FTC250371	Vrac / Bulk	12	120
Intérieur TC Plastique / Plastic inside				
2 usages / 2 holes				
	FTC250461	Vrac / Bulk	12	120

BUREAU

Intérieur métal

Metal inside

Réserve vissée

Screwed-on bin

Corps plastique

Plastic body



Intérieur métal



FTC250571



Modèle	Réf.	Conditionnement	UV	PCB
Model	Ref.	Packing		
Intérieur TC Métal / Métal inside				
2 usages / 2 holes				
	FTC250571	Vrac / Bulk	12	120

Taill'Electron

Intérieur métal

Metal inside

Corps plastique

Plastic body

Intérieur métal



853252

Modèle	Réf.	Conditionnement	UV	PCB
Model	Ref.	Packing		
Intérieur TC Métal / Métal inside				
2 usages / 2 holes				
	853252	Vrac / Bulk	10	100



Too'dou

SCOLAIRE

Intérieur plastique

Plastic inside

2 usages

2 holes

Corps plastique / Toucher doux

Soft touch plastic body



Intérieur plastique

FTC250863



Modèle	Réf.	Conditionnement	UV	PCB
Model	Ref.	Packing		
2 usages / 2 holes				
	FTC250863	Vrac / Bulk	12	144

TAILLE - CRAYONS RÉSERVE 3 USAGES / 3-HOLE BIN SHARPENERS

Taill'Tou

Intérieur plastique

Plastic inside

3 usages

3 holes

Le taille-crayons spécial gros crayons
-- jusqu'à Ø 17 mm --

The 3 holes sharpener for any diameter pencil - up to Ø 17 mm

2 1 3 usages



3 usages



FTC350063



Système d'ouverture



« TAILL'TOU » 3 usages

Taille-crayons à l'unité

Réf. FTC350063

Livré en boîte de 20 pces

Modèle	Réf.	Conditionnement	UV	PCB
Model	Ref.	Packing		
3 usages / 3 holes				
	FTC350063	Vrac / Bulk	20	400

▪ MACHINES À TAILLER / DESKTOP PENCIL SHARPENERS

Avec réservoir pour copeaux
With reservoir for shavings

Fraise acier
Steel mill

Etrier de fixation
Fixing stirrup



850912

∅ 8 mm



FTC500071

Modèle	Réf.	Conditionnement	UV	PCB
Model	Ref.	Packing		
Jusqu'à ∅ 8 mm				
	FTC500071	Boîte / Box	1	30
Fraise de rechange pour réf. FTC500071 / Spare mill for FTC500071				
	850912	Vrac / Bulk	1	200



∅ 8 mm à 12 mm

Réglage de la fraise par bouton molette
sur l'arrière de la machine :

Adjusting of the sharpening blade thanks to the metal
milling wheel on the back of the desktop sharpener :

- pour crayon ∅ 8 mm à 12 mm

- for normal pencil and jumbo-size pencil from ∅ 8 mm to 12 mm



FTC500171

Modèle	Réf.	Conditionnement	UV	PCB
Model	Ref.	Packing		
Jusqu'à ∅ 12 mm				
	FTC500171	Boîte / Box	1	36
Fraise de rechange pour réf. FTC500171 / Spare mill for FTC500171				
	850922	Vrac / Bulk	1	100





TAILLE - CRAYONS ÉLECTRIQUE / ELECTRIC PENCIL SHARPENER

Taille-crayons électrique 2 usages
2-Hole electric sharpener

Pour des crayons avec un diamètre allant de 6 à 12 mm
For pencils with diameter from 6 to 12 mm

Le trou « gros module » est protégé par un clapet
"Large hole" is protected by a flap



FTC150163



Fonctionne sur secteur ou avec 4 piles LR6 (non fournies)
Works on mains supply (adaptor included) or batteries LR6 (Not included)



Modèle Model	Réf. Ref.	Conditionnement Packing	UV	PCB
	FTC150163	Boîte / Box	1	48

Fraise acier
Steel mill

Pour crayon à calibre standard
For standard size pencil

Se met en route automatiquement
lorsque vous insérez le crayon
Automatically starts when the pencil is inserted

Fonctionne avec 4 piles LR 6 (non fournies)
Battery operated (4 batteries LR 6 not included)



**+ 1 lame de rechange
sous le taille-crayon**
+ 1 spare blade below sharpener



FTC150063



Modèle Model	Réf. Ref.	Conditionnement Packing	UV	PCB
	FTC150063	Boîte / Box	1	72

■ CUTTERS / CUTTERS

Cutters lames 9 mm / 9 mm cutters

Plastique / Plastic

Corps plastique

Plastic body

Curseur sécurité blocage de lame

Safety mechanism : automatic blade locking



BCU090062

Modèle	Réf.	Conditionnement	UV	PCB
Model	Ref.	Packing		
	BCU090062	Pegboardable	24	768



Corps plastique ABS, glissière métal

ABS plastic body with metal slide

Blocage manuel de la lame

Manual locking system

Embout casse-lame

Snap-off blade system



BCU090162

Couleurs assorties / Assorted colours

Modèle	Réf.	Conditionnement	UV	PCB
Model	Ref.	Packing		
	BCU090162	Pegboardable	10	240



Plastique bi-matière / Bi-material plastic

Plastique bi-matière, glissière métal

Bi-material plastic, metal slide

Sécurité : système autobloquant de lame

Safety mechanism : automatic blade locking

+ 3 lames de rechange dans le manche

+ 3 spare blades inside the cutter

Rechargement automatique de lame

Automatic blade reloading



BCU090282

Modèle	Réf.	Conditionnement	UV	PCB
Model	Ref.	Packing		
	BCU090282	Pegboardable	12	240



Métal / Metal

Métal, clip d'attache

Metal body, fastening clip

Encoche casse-lame usagée

Notch for breaking worn blade



401022

Modèle	Réf.	Conditionnement	UV	PCB
Model	Ref.	Packing		
	401022	Pegboardable	10	480





Cutters lames 18 mm / 18 mm cutters

Plastique / Plastic

Corps plastique

Plastic body

Blocage manuel de la lame

Manual blade locking



BCU180062



Modèle	Réf.	Conditionnement	UV	PCB
Model	Ref.	Packing		
	BCU180062	Pegboardable	12	288

Plastique bi-matière / Bi-material plastic

Plastique ABS et acier inoxydable, glissière métal

ABS plastic and stainless steel cutter, metal slide

Système de blocage de lame par serrage d'une molette

Locking blade system with tightening knob

+ 2 lames de rechange dans le manche

+ 2 spare blades inside the cutter



BCU180182



Modèle	Réf.	Conditionnement	UV	PCB
Model	Ref.	Packing		
	BCU180182	Pegboardable	12	192

Bi-matière à cassette / Bi-material with incorporated tray

Plastique bi-matière, glissière métal

Bi-material plastic body, metal slide

+ cassette métal rechargeable de 6 lames de rechange incorporée dans le manche

+ Metal tray of 6 spare blades inside the cutter

Rechargement automatique de lame

Automatic blade reloading

Sécurité : double système de blocage de la lame par curseur et molette

Safety mechanism : double blade locking system by slider and tightening knob.



401508



Modèle	Réf.	Conditionnement	UV	PCB
Model	Ref.	Packing		
	401508	Cutter + cassette de 6 lames / Cutter with incorporated tray 6 blades	12	48
	403142	Cassette de 6 lames de rechange pour cutter 401508 / Metal tray of 6 spare blades for cutter 401508	24	240

Cutter de sécurité / Safety cutter

Métal, lame auto-rétractable

Metal, auto-retractable blade

+ 1 lame de rechange

+ 1 spare blade



BCU300082



Modèle	Réf.	Conditionnement	UV	PCB
Model	Ref.	Packing		
	BCU300082	Cutter + 1 lame de rechange / Cutter + 1 spare blade	10	120
	402918	5 lames de rechange / 5 spare blades	12	300

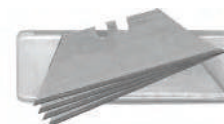

402918



Lames de rechange pour cutter / Cutter spare blades

Étui rigide de 10 lames de rechange

Rigid plastic case of 10 spare blades

9 mm - Sécables - 11 tronçons

9 mm - Divisible into 11 sections

18 mm - Sécables - 7 tronçons

18 mm - Divisible into 7 sections



Modèle / Model	Réf. / Ref.	Conditionnement / Packing	UV	PCB
9 mm	BLC090171	Vrac / Bulk	10	100
9 mm	BLC090072	Pegboardable	25	200
18 mm	BLC180171	Vrac / Bulk	10	100
18 mm	BLC180272	Pegboardable	25	200



BLC090171

BLC180171



BLC090072



BLC180272

Cutters de précision / Precision cutters

Entièrement métallique - 140 mm

Made of metal only - 140 mm

Coffret cutter - Réf. BCU400372

Bi-matière

Bi-material

Pour arts graphiques, modélisme...

For graphic arts, model-making...

1 cutter livré avec 6 lames assorties

1 cutter comes with 6 assorted blades

Embout aimanté

Magnetised tip



BLC400072



BCU400372

Modèle / Model	Réf. / Ref.	Conditionnement / Packing	UV	PCB
Cutter de précision tout métal 140 mm / 140 mm full-metal precision cutter				
Small / Small	409028	Pegboardable	12	120
Large / Large	409068	Pegboardable	12	120
Étui rigide de lames de rechange / Rigid plastic case of spare blades				
12 lames "Small"	BLC400072	Pegboardable	12	360
10 lames "Large"	403968	Pegboardable	12	360
Coffret cutter + 6 lames / Case-cutter + 6 blades				
	BCU400372	Pegboardable	1	120



409068



409028

Cutter compas / Compass cutter

Pour coupes circulaires de Ø 10 à 150 mm

For Ø 10 to 150 mm circular cuts

Modèle / Model	Réf. / Ref.	Conditionnement / Packing	UV	PCB
Cutter compas / Compass cutter				
	408118	Pegboardable	1	288
Étui rigide de 12 lames de rechange / Rigid plastic case of 12 spare blades				
	408318	Pegboardable	1	120



408118



408118



■ ACCESSOIRES DE COUPE / CUTTING ACCESSORIES

Plaques de coupe / Cutting mats

Qualité supérieure / High quality
APQ400061 - APQ300061 - APQ200061 - APQ100061

Épaisseur 3 mm

3 mm thickness

Résistance à la coupe

Cut-resistant

Surface quadrillée

Cross-ruled surface

Triple épaisseur

3 layers (total 3 mm)

Auto-cicatrisante

Self-healing

Impression recto-verso

Printed on both sides

Lignes d'angles 30°, 45° et 60°

Lines with 30°, 45° and 60° angles



Qualité supérieure
High quality

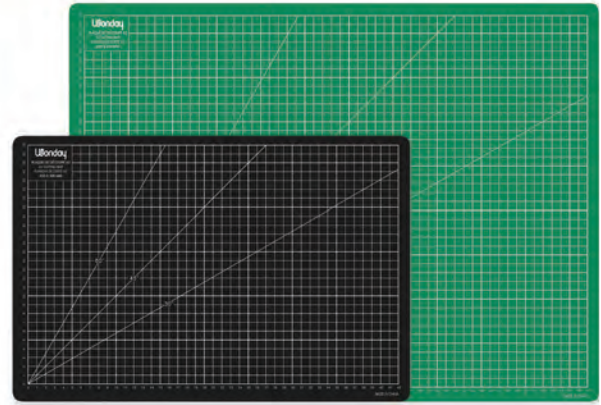

APQ200061



Modèle	Réf.	Conditionnement	UV	PCB
Model	Ref.	Packing		
Qualité supérieure / High quality				
Format A4 - 300 x 220 mm				
	APQ400061	Vrac / Bulk	1	60
Format A3 - 450 x 300 mm				
	APQ300061	Vrac / Bulk	1	10
Format A2 - 600 x 450 mm				
	APQ200061	Vrac / Bulk	1	10
Format A1 - 600 x 900 mm				
	APQ100061	Vrac / Bulk	1	10

Épaisseur 3 mm

3 mm thickness

Résistance à la coupe

Cut-resistant

Surface quadrillée

Cross-ruled surface

Lignes d'angles 30°, 45° et 60°

Lines with 30°, 45° and 60° angles

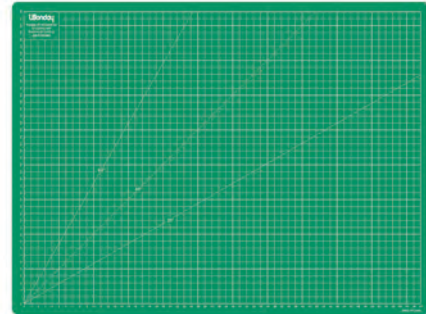

APQ300061



Modèle	Réf.	Conditionnement	UV	PCB
Model	Ref.	Packing		
Format A3 - 450 x 300 mm				
	APQ300061	Vrac / Bulk	1	10
Format A2 - 600 x 450 mm				
	APQ200061	Vrac / Bulk	1	10
Format A1 - 900 x 600 mm				
	APQ100061	Vrac / Bulk	1	10

Règles de coupe / Cutting rulers

Pour traçage et coupe

Drawing and cutting functions

Aluminium anodisé

Anodised aluminium

Bande de caoutchouc antidérapante,
bord de coupe en acier inoxydable

Anti-slip rubber surface, stainless steel cutting edge



FTT400271



Modèle	Réf.	Conditionnement	UV	PCB
Model	Ref.	Packing		
Règles de coupe / Cutting rulers				
30 cm	FTT300271	Étui / Pouch	1	10
40 cm	FTT400271	Étui / Pouch	1	10
50 cm	FTT500271	Étui / Pouch	1	10
60 cm	FTT600271	Étui / Pouch	1	10
80 cm	FTT800271	Étui / Pouch	1	10
100 cm	FTT000271	Étui / Pouch	1	10



Agrafeuses de poche / Pocket-size staplers

Corps ABS

ABS body

Enclume, ressort et magasin métal

Metal anvil, spring and compartment

Arrache-agrafes incorporé

Staple-removal function

+ boîte 1000 agrafes n°10

+ box of 1000 n°10 staples



FAG100162



FAG100162



Modèle	Réf.	Conditionnement	UV	PCB
Model	Ref.	Packing		
Agrafeuse N°10 - 12 feuilles / N°10 stapler - 12 sheets				
		FAG100162 Pegboardable	12	120

Mécanisme métal

Metal mechanism

Chromée

Chrome-plated

Arrache-agrafes incorporé

Staple-removal function



FAG100272



FAG100272



Modèle	Réf.	Conditionnement	UV	PCB
Model	Ref.	Packing		
Médium / Medium				
Agrafeuse N°10 - 10 feuilles / N°10 stapler - 10 sheets				
		FAG100272 Pegboardable	12	144

Enclume et mécanisme métal

Metal anvil and mechanism

+ boîte de 1000 agrafes n°10

+ box of 1000 n°10 staples



100218



100218

Modèle	Réf.	Conditionnement	UV	PCB
Model	Ref.	Packing		
Mini / Mini +1000 agrafes / +1000 staples				
Agrafeuse N°10 - 15 feuilles / N°10 stapler - 15 sheets				
		100218 Pegboardable	12	144



Class'n'buro

Mécanisme métal
Metal mechanism
Anti-glisser
Anti-slip

Réf. FAG100362 Agrafeuse rotative n°10
Ref.FAG100362 Rotating n°10 stapler

2 positions d'agrafage : "Classique" ou " Brochure"
2 stapling positions : « Regular » or « Leaflets »

Profondeur d'agrafage : 60 mm
Stapling depth: 60 mm



Idéale pour vos brochures
Perfect for leaflets



FAG100362



Modèle	Réf.	Conditionnement	UV	PCB
Model	Ref.	Packing		
Agrafeuse N°10 - 12 feuilles / N°10 stapler - 12 sheets				
Rotative / Rotating	FAG100362	Pegboardable	12	120

Initial

Mécanisme métal
Metal mechanism



FAG240082



FAG240082



Modèle	Réf.	Conditionnement	UV	PCB
Model	Ref.	Packing		
Agrafeuse 24/6 26/6 - 20 feuilles / 24/6 26/6 stapler - 20 sheets				
	FAG240082	Pegboardable	12	72

Class'n'buro corps métal / Metal body

Ressort métal
Metal spring
Agrafe et épingle
Both staples and fastens



102001



101001

Modèle	Réf.	Conditionnement	UV	PCB
Model	Ref.	Packing		
Agrafeuse 24/6 26/6 - 20 feuilles / 24/6 26/6 stapler - 20 sheets				
	101001	Pegboardable	12	72
Agrafeuse 24/6 26/6 - 25 feuilles / 24/6 26/6 stapler - 25 sheets				
	102001	Pegboardable	12	60

■ AGRAFEUSE LONG BRAS / LONG ARM STAPLER

Profondeur d'agrafage 300 mm
Stapling depth 300 mm



FAG300073

Modèle	Réf.	Conditionnement	UV	PCB
Model	Ref.	Packing		
Agrafeuse 24/6 26/6 - 15 feuilles / 24/6 26/6 stapler - 15 sheets				
■	FAG300073	Boîte / Box	1	36

■ AGRAFEUSE LONG BRAS GRANDE CAPACITÉ / HEAVY DUTY LONG ARM STAPLER

Capacité d'agrafage : 100 feuilles
Stapling capacity : 100 sheets

Profondeur d'agrafage : 215 mm
Stapling depth : 215 mm

Capacité du magasin : 100 agrafes
Staple loading capacity : 100 staples

Utilise des agrafes 23/10 ou 23/13
Uses 23/10 or 23/13 staples



103021

Modèle	Réf.	Conditionnement	UV	PCB
Model	Ref.	Packing		
Agrafeuse 23/10 ou 23/13 - 100 feuilles / 23/10 or 23/13 stapler - 100 sheets				
■	103021	Boîte / Box	1	6

■ AGRAFEUSE GRANDE CAPACITÉ / HEAVY DUTY STAPLER

Poignée en matière souple pour un plus grand confort d'utilisation
Handle made in supple material for more comfort

Compartiment intégré pour recharge d'agrafes
Incorporated compartment for staple refill

Base renforcée
Reinforced base

Livré avec 1 boîte de 1000 agrafes 23/10
Comes with a box of 1000 23/10 staples



103011

Modèle	Réf.	Conditionnement	UV	PCB
Model	Ref.	Packing		
Agrafeuse 23/10 - 60 feuilles + 1000 agrafes / 23/10 stapler - 60 sheets + 1000 staples				
■	103011	Boîte / Box	1	24



■ PINCE-AGRAFEUSES / PLIER-STAPLERS

Initial

Mécanisme métal
Metal mechanism



FAG100482

8/4



FAG080082

N°10



FAG100482



24/6
26/6



FAG240382

Modèle	Réf.	Conditionnement	UV	PCB
Model	Ref.	Packing		
Pince agrafeuse 8/4 - 12 feuilles / 8/4 plier-stapler - 12 sheets				
8/4	FAG080082	Pegboardable	12	96
Pince agrafeuse N°10 - 15 feuilles / N°10 plier-stapler - 15 sheets				
N°10	FAG100482	Pegboardable	12	96
Pince agrafeuse 24/6 26/6 - 20 feuilles / 24/6 26/6 plier-stapler - 20 sheets				
24/6 - 26/6	FAG240382	Pegboardable	12	48

Pince agrafeuse « sans effort » Low-force plier stapler

Mécanisme métal
Metal mechanism

Capacité d'agrafage : 20 feuilles avec des agrafes 24/6
et 25 feuilles avec des agrafes 26/6
Stapling capacity: 20 sheets with 24/6 staples and 25 sheets
with 26/6 staples.

50% d'effort en moins
50% less effort

Livrée avec une boîte de 1000 agrafes 24/6
Comes with 1000 24/6 staples

Livrée avec une notice d'utilisation
Comes with instruction use.



107711

Modèle	Réf.	Conditionnement	UV	PCB
Model	Ref.	Packing		
24/6 - 26/6	107711	Pegboardable	12	48

Pince-agrafeuses de poche Lily'Puss / Pocket-size plier-staplers

Mini pince-agrafeuse N°10
Mini N°10 plier-stapler

Corps métal
Metal body

Mécanisme métal
Metal mechanism



100501 x 18 pcs



100401



10,5 cm

100901

Modèle	Réf.	Conditionnement	UV	PCB
Model	Ref.	Packing		
Pince-agrafeuse N°10 - 20 feuilles / N°10 plier-stapler - 20 sheets				
	100401	Pegboardable	18	108
	100501	Pegboardable	18	108
	100901	Pegboardable	18	108

■ AGRAFEUSE ÉLECTRIQUE / ELECTRIC STAPLER

Capacité d'agrafage : 15 à 20 feuilles

Stapling capacity : 15 to 20 sheets

Utilise des agrafes 24/6 ou 26/6

Uses 24/6 or 26/6 staples

Bouton poussoir au dos

Release button at the back



FAG240563



Fonctionne sur secteur
Power supply



Chargement frontal des agrafes
Front-loading staples

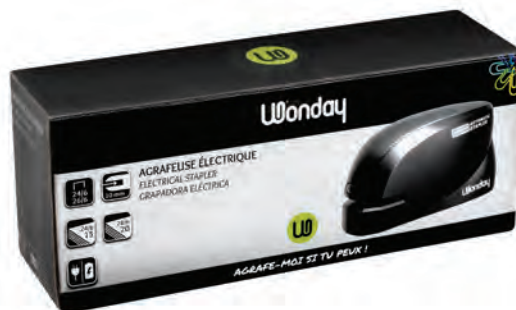

Modèle	Réf.	Conditionnement	UV	PCB
Model	Ref.	Packing		
Agrafeuse 24/6 ou 26/6 - 15 à 20 feuilles / 24/6 or 26/6 stapler - 15 to 20 sheets				
■	FAF240563	Boîte / Box	1	6

■ AGRAFES / STAPLES

Acier galvanisé

Zinc-plated steel



Taille	Boîte 1000 pces UV 50 - 500	Boîte 5000 pces UV 10 - 100
Size	Box	Box
Galvanisé / Galvanised		
8/4	FAF080073	FAF080173
N°10	FAF100073	FAF100173
24/6	FAF240073	FAF240173
26/6	FAF260073	FAF260173
26/8	-	117151
23/10	FAF230273 <small>pour ce modèle : 50/200</small>	-



■ ÔTE-AGRAFES / STAPLE REMOVERS

Ôte-agrafes
Staple remover

Corps plastique

Plastic body

Mécanisme métal

Metal mechanism



FOT010061



FOT010162

FOT010162

Avec système de blocage

With locking system



FOT010162



Modèle	Réf.	Conditionnement	UV	PCB
Model	Ref.	Packing		
■	FOT010061	Vrac / Bulk	24	288
■	FOT010162	Pegboardable	12	288

Pince à dégrafer
Iron staple remover

Chromé

Chrome-plated



FOT020072



FOT020072



Modèle	Réf.	Conditionnement	UV	PCB
Model	Ref.	Packing		
Pince	FOT020072	Pegboardable	1	144

■ DISTRIBUTEURS DE CLIPS / PAPER CLIPPER

Pince distributrice de clips

Paper clipper dispenser

Utilise des clips chromés

Distributes chrome plated clips

Pour relier 2 à 50 feuilles d'une simple pression sur le poussoir

Simple pressing of the button to attach up to 50 sheets



750101



750911

Modèle	Réf.	Conditionnement	UV	PCB
Model	Ref.	Packing		
Pince / Paper clipper	750101	Boîte / Box	12	96
Boîte de 50 clips nickelés / Box of 50 nickel-plated clips				
4,8 mm	750911	Boîte / Box	12	288
6,4 mm	750921	Boîte / Box	12	288

■ PERFORATEUR 1 TROU / 1 HOLE PUNCH

Métal laqué
Lacquered



FPE010072



FPE010072



Modèle	Réf.	Conditionnement	UV	PCB
Model	Ref.	Packing		
20 feuilles / 20 sheets				
	FPE010072	Pegboardable	12	144

■ PERFORATEURS 2 TROUS / 2 HOLES PUNCHES

Class'n'buro "Tout métal"

Corps et mécanisme métal
Metal body and mechanism

2 trous
2 holes

Ecartement 80 mm
80 mm space between holes

Avec guide de réglage
With ruler guide



Bouton presseur pour bloquer le perforateur "fermé"

FPE020273



FPE020172



Modèle	Réf.	Conditionnement	UV	PCB
Model	Ref.	Packing		
10 feuilles / 10 sheets - 10 x 5,5 x 5,5 cm				
<input type="checkbox"/>	FPE020172	Pegboardable	12	72
20 feuilles / 20 sheets - 11 x 8 x 8 cm				
<input checked="" type="checkbox"/>	FPE020273	Pegboardable	12	48



105401

Modèle	Réf.	Conditionnement	UV	PCB
Model	Ref.	Packing		
35 feuilles 13,5 x 12,5 x 12,5 cm / 35 sheets				
<input checked="" type="checkbox"/>	105401	Pegboardable	1	12



Class'n'buro

- Levier renforcé
Strengthened control lever
- Mécanisme métal
Metal mechanism
- Ecartement 80 mm
80 mm space between holes
- Avec guide de réglage
With ruler guide



FPE020072



Modèle	Réf.	Conditionnement	UV	PCB
Model	Ref.	Packing		
16 feuilles / 16 sheets				
■	FPE020072	Pegboardable	1	48

■ **PERFORATEURS 4 TROUS / 4 HOLES PUNCHES**

Initial

- Corps et mécanisme métal
Metal body and mechanism
- Ecartement 80 mm
80 mm space between holes
- Avec guide de réglage
With ruler guide



FPE040072



Modèle	Réf.	Conditionnement	UV	PCB
Model	Ref.	Packing		
20 feuilles 28 x 8 x 8 cm / 20 sheets				
■	FPE040072	Pegboardable	1	24

Class'n'buro

- Corps et mécanisme métal
Metal body and mechanism
- Ecartement 80 mm
80 mm space between holes
- Avec guide de réglage
With ruler guide



105531

Modèle	Réf.	Conditionnement	UV	PCB
Model	Ref.	Packing		
20 feuilles 27 x 9 x 7,5 cm / 20 sheets				
■	105531	Pegboardable	1	12

ADHÉSIFS / TAPE ROLLS

Adhésif d'emballage / Packing tape

BOPP

Bi-Oriented PolyPropylene

Colle acrylique

Acrylic glue

Bonne élasticité

Good elasticity

50 mm x 66 m

50 mm x 66 m

Havane
Brown

Silencieux
Déroulage très facile.
Adaptez le serrage
du dévidoir.

Adhésif
Polypropylène

**Havane
silencieux**
45 microns
No noise

GAD300111

Havane
45 microns

GAD300011

Gamme
ECO



Couleurs
Colours

47 microns



GAD400011



GAD400111



GAD400211



GAD400311

Imprimés
Printed

FRAGILE
50 microns

GAD200011

**BANDE DE
GARANTIE**
50 microns

GAD200111

Transparent
Transparent



TRANSPARENT
47 microns

GAD100011



Modèle	Réf.	Conditionnement	UV	PCB
Model	Ref.	Packing		
1 rouleau d'adhésif HAVANE / 1 brown tape roll				
Eco	GAD300011	Vrac / Bulk	6	36
Silencieux	GAD300111	Vrac / Bulk	6	36
1 rouleau d'adhésif imprimé / 1 printed tape roll				
FRAGILE	GAD200011	Vrac / Bulk	6	36
BANDE DE GARANTIE	GAD200111	Vrac / Bulk	6	36
1 rouleau d'adhésif d'emballage transparent / 1 transparent packing tape roll				
TRANSPARENT	GAD100011	Vrac / Bulk	6	36
BLEU	GAD400011	Vrac / Bulk	6	36
VERT	GAD400111	Vrac / Bulk	6	36
ROUGE	GAD400211	Vrac / Bulk	6	36
JALINE	GAD400311	Vrac / Bulk	6	36



Adhésif transparent / Transparent tape

BOPP
Bi-Oriented PolyPropylene
Colle acrylique
Acrylic glue
Bonne élasticité
Good elasticity

Réf. FAD100011
19 mm x 66 m
19 mm x 66 m
Sachet individuel
Individual pouch



FAD100011
43 microns



FAD100111
43 microns

Adhésif Polypropylène

Réf. FAD100111
19 mm x 33 m
19 mm x 33 m
Lot de 8 rouleaux
Set of 8 rolls



Modèle	Réf.	Conditionnement	UV	PCB
Model	Ref.	Packing		
1 rouleau d'adhésif transparent / 1 transparent tape roll				
19 mm x 66 m	FAD100011	Vrac / Bulk	8	96
Lot de 8 rouleaux d'adhésif transparent / Set of 8 transparent tape rolls				
19 mm x 33 m	FAD100111	Vrac / Bulk	1	72

Adhésif invisible / Invisible tape

BOPP
Bi-Oriented PolyPropylene
Colle acrylique
Acrylic glue
Bonne élasticité
Good elasticity
19 mm x 33 m
19 mm x 33 m



345402
50 microns

Adhésif Polypropylène

Modèle	Réf.	Conditionnement	UV	PCB
Model	Ref.	Packing		
Lot de 4 rouleaux d'adhésif invisible / Set of 4 invisible tape rolls				
19 mm x 33 m	345402	Vrac / Bulk	1	144

■ PÂTE ADHÉSIVE / TACK GLUE DOTS

Pâte adhésive / Tack glue dots

Multiusage
Multipurpose
Toutes surfaces
Any surface
Ne tâche pas
Do not stain



669095

Économique
Economical
Pré-découpée
Precut
100 g
100 g



Modèle	Réf.	Conditionnement	UV	PCB
Model	Ref.	Packing		
100 g	669095	Pegboardable	20	120

■ DÉVIDOIRS / TAPE DISPENSERS

Dévidoirs escargot pour adhésif 19 mm x 33 m*

19 mm x 33 m "Snail" tape dispensers*

Lame acier
Steel blade



FAD950062



FAD900261



FAD900062



FAD900191

Modèle	Réf.	Conditionnement	UV	PCB
Model	Ref.	Packing		
Transparent / Transparent				
<input type="checkbox"/>	FAD900062	Pegboardable	12	144
Couleurs transparentes / Transparent colours				
<input checked="" type="checkbox"/>	FAD900191	Vrac / Bulk	20	300
Noir				
<input checked="" type="checkbox"/>	FAD900261	Vrac / Bulk	20	240
Dévidoir + ruban adhésif / Tape dispenser + tape				
<input type="checkbox"/>	FAD950062	Pegboardable	12	144

Dévidoirs lourds pour adhésif 19 mm x 33 m*

/ 19 mm x 33 m heavy tape dispensers*

Socle lesté
Weighted base
Lame acier
Steel blade

GAMME ARRONDIE
/ ROUNDED RANGE



FAD900563



GAMME CLASSIQUE
/ CLASSIC RANGE



FAD900363

Modèle	Réf.	Conditionnement	UV	PCB
Model	Ref.	Packing		
GAMME CLASSIQUE / CLASSIC RANGE				
Medium M / Medium M 143 x 60 x 90 mm				
<input checked="" type="checkbox"/>	FAD900363	Boîte / Box	1	24
GAMME ARRONDIE / ROUNDED RANGE				
Medium S / Medium S 110 x 51 x 48 mm				
<input checked="" type="checkbox"/>	FAD900463	Boîte / Box	1	48
Medium M / Medium M 143 x 61 x 56 mm				
<input checked="" type="checkbox"/>	FAD900563	Boîte / Box	1	36

Socle lesté
Weighted base
Base antidérapante
Non-skid base
Pour rouleau 33 m,
largeur max 20 mm
For 33 m tape, maximum
width 20 mm



900459

ELAMI

Modèle	Réf.	Conditionnement	UV	PCB
Model	Ref.	Packing		
Dévidoir lourd design / Design heavy tape dispenser 135 x 60 x 90 mm				
<input checked="" type="checkbox"/>	900459	Boîte carton / Carton box	1	10



Dévidoirs lourds pour adhésifs 19 mm x 33 m & 66 m*
 / 19 mm x 33 m & 66 m heavy tape dispensers*

Lame acier
 Steel blade
 Socle lesté
 Weighted base

GAMME CLASSIQUE
 / CLASSIC RANGE



GAD900063

GAMME ARRONDIE
 / ROUNDED RANGE



858611

Modèle	Réf.	Conditionnement	UV	PCB
Model	Ref.	Packing		
GAMME CLASSIQUE / CLASSIC RANGE		215 x 85 x 104 mm		
■	GAD900063	Boîte / Box	1	12
GAMME ARRONDIE / ROUNDED RANGE		185 x 88 x 82 mm		
■	858611	Boîte / Box	1	12

Dévidoir lourd 2 rouleaux en métal pour rouleaux 25 mm x 66 m et 100 m*
 / 2-rolls heavy tape dispenser for 25 mm x 66 m and 100 m rolls*

Corps métal
 Metal body



900046



Modèle	Réf.	Conditionnement	UV	PCB
Model	Ref.	Packing		
Dévidoir 2 rouleaux / Heavy tape dispenser 2 rolls		200 x 100 x 130 mm		
	900046	Boîte carton / Carton box	1	8

Dévidoir à poignée pour rouleaux 66 m et 100 m*
 / Carton sealer for 66 m and 100 m rolls*

Tension réglable
 Tightening adjustment
 Lame auto-rétractable
 Self-retracting blade
 Mandrin ø 50 mm
 Core ø 50 mm



GAD900263



Modèle	Réf.	Conditionnement	UV	PCB
Model	Ref.	Packing		
Corps plastique / Plastic body				
	GAD900263	Boîte / Box	1	24

Ruban de scratch auto-agrippant "EASY Scratch"
/ "EASY Scratch" self-gripping hook and loop tape

20 mm x 2,5 m
20 mm x 2,5 m

Multiusage : pour le bureau, la maison, le jardin, l'école...
Multi-purpose : for office, at home, in the garden, at school...

Réutilisable et réversible
Reusable and reversible

Ultra résistant à la traction
Can withstand extreme pulls

Pour usages intérieur et extérieur
For indoor and outdoor use



766201



000043



Modèle Model	Réf. Ref.	Conditionnement Packing	UV	PCB
1 rouleau de scratch auto-agrippant / 1 self-gripping hook and loop tape roller				
Blanc	766201	Boîte / Box	6	144
Noir	766211	Boîte / Box	6	144
Vert	766221	Boîte / Box	6	144
Orange fluo	766231	Boîte / Box	6	144
Présentoir de 24 pces en couleurs assorties / Display of 24 pces in assorted colours				
24 pces	000043	Boîte / Box	1	6

▪ **ATTACHES** / CLIPS

Distributeurs magnétiques de trombones
/ Magnetic paper clip dispensers

Distributeurs magnétiques de trombones
Magnetic paper clip dispensers

Réf. FTB900062

Livré avec 50 trombones couleurs assorties
Comes with 50 vinyl-coated coloured clips



750202



FTB900062



Modèle Model	Réf. Ref.	Conditionnement Packing	UV	PCB
Distributeur magnétique + 50 trombones / Magnetic paper clip dispenser + 50 paper clips				
■	FTB900062	Pegboardable	10	100
Distributeurs magnétiques / Magnetic paper clip dispensers				
■	750202	Boîte / Box	12	144



NOUVEAUX SACHETS REFERMABLES

Trombones / Paper clips

Acier galvanisé
Galvanised steel



Ronds / Rounded



Chevron / Triangular



FTB300472



FTB250073

	Sachet plastique LS / Hanging plastic pouch	Boîte carton / Carton box	
	Ronds / Rounded	Chevron / Triangular	
Droits	100 pces UV 20 - PCB 120	100 pces UV 10 - PCB 100	1000 pces UV 1
25 mm	FTB250772	FTB250073	FTB250173 (PCB 25)
30 mm	FTB300472	741302	-
32 mm	FTB320672	FTB320073	FTB320173 (PCB 12)

Acier nickelé / Nickel-plated



	Boîte carton / Carton box	100 pces	UV - PCB
50 mm ondulés / waved		FTB500073	4 - 40
77 mm ondulés / waved		FTB770073	4 - 40

Couleur / Coloured



FTB250992

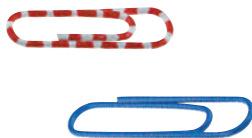

	Sachet plastique LS / Hanging plastic pouch	Boîte carton / Carton box	
		100 pces UV 10 - PCB 100	1000 pces UV 1
	UV 20 - PCB 120		
25 mm Fantaisie / Fancy	80 pces - FTB250892	-	-
25 mm	100 pces - FTB250992	FTB250593	740254 (PCB 30)
32 mm	-	FTB320593	FTB320693 (PCB 25)
50 mm Géantes / Jumbo	20 pces - FTB500192	-	-

Attaches parisiennes / Fastening clips



FFI050872



FFI050672



FFI050872



Modèle Model	Réf. Ref.	Conditionnement Packing	UV	PCB
40 pces - Dorées / Golden				
16 mm	FFI050572	Pegboardable	20	120
19 mm	FFI050672	Pegboardable	20	120
25 mm	FFI050772	Pegboardable	20	120
40 pces - Argentées / Silver				
Assorties	FFI050872	Pegboardable	20	120

Attaches papillon / Butterfly paper clips



FFI100073



Modèle	Réf.	Conditionnement	UV	PCB
Model	Ref.	Packing		
30 x 40 mm				
100 pces	FFI100073	Boîte carton / Carton box	1	15
10 pces	FFI100272	Pegboardable	25	300
47 x 60 mm				
50 pces	FFI100373	Boîte carton / Carton box	1	15

■ PUNAISES - ÉPINGLES / PUSH AND MAP PINS



FFI000672

FFI000592



FFI000892



FFI000672

FFI000772

FFI000872



FFI010292



Modèle	Sachet plastique LS / Hanging plastic pouch	Boîte carton 100 pces / Carton box
Model	UV / PCB	UV / PCB
Punaises / Push pins		
Couleurs assorties / Assorted colours	100 pces - FFI000592 20 / 120	FFI000293 10 / 100
Signalétiques Couleurs assorties / Coloured memo Assorted colours	36 pces - FFI000892 20 / 120	FFI000493 4 / 40
Laitonnées / Brass-plated	100 pces - FFI000672 20 / 120	FFI000073 10 / 100
Nickelées «type baïonnette» / Nickel-plated	50 pces - FFI000772 20 / 120	
Nickelées 3 pointes / Nickel-plated 3 pins	50 pces - FFI000872 20 / 120	
Épingles et pinces / Map pins and pegs		
Épingles couleurs ø 4 mm / Coloured map pins ø 4 mm	50 pces - FFI010292 20 / 120	

■ AIMANTS / MAGNETS



FAI090102



FAI090102



FAI090202



FAI300792

FAI200092



FAI701111



Modèle	Pegboardable
Model	UV / PCB
ø 9 mm argentés / Silver colour	
	12 pces - FAI090102
ø 9 mm dorés / Gold colour	
	12 pces - FAI090202
Couleurs assorties transparentes - coiffe plastique / Assorted transparent colours - covered with plastic 30 mm	
	5 pces - FAI300792
Model	UV / PCB
Couleurs assorties - coiffe plastique / Assorted colours - covered with plastic	
15 mm	10 pces - FAI150092
20 mm	6 pces - FAI200092
30 mm	4 pces - FAI300092
40 mm	2 pces - FAI400092

Modèle	Sachet plastique / Plastic bag
Model	UV / PCB
Bandes aimantées adhésives / Magnetic adhesive strips 300 x 20 x 2 mm	
	10 pces - FAI701111





■ PINCES À DESSIN / BINDER CLIPS

Pinces "double clip" / "Double" binder clips



FPI190372



FPI190273



Modèle	Boîte plastique / Plastic box	Sachet plastique LS / Hanging plastic pouch
Model	UV / PCB	UV / PCB
19 mm - Mini Couleurs assorties / Assorted colours	40 pces - FPI190273 1 / 96	6 pces - FPI190372 20 / 120



FPI320172



FPI320073



FPI320073



Modèle	Boîte carton 12 pces / Carton box 12 pces	Sachet LS / Hanging pouch
Model	UV / PCB	UV / PCB
19 mm - Ecartement 6 mm / Opening capacity 6 mm	759192 1 / 240	12 pincettes - FPI190172 10 / 200
25 mm - Ecartement 8 mm / Opening capacity 8 mm	FPI250073 1 / 240	6 pincettes - FPI250172 10 / 200
32 mm - Ecartement 10 mm / Opening capacity 10 mm	FPI320073 1 / 144	6 pincettes - FPI320172 10 / 200
41 mm - Ecartement 15 mm / Opening capacity 15 mm	FPI410073 1 / 100	3 pincettes - FPI410172 10 / 200
51 mm - Ecartement 20 mm / Opening capacity 20 mm	FPI510073 1 / 60	2 pincettes - FPI510172 10 / 200

Pinces "bulldog" / Nickel-plated "bulldog" binder spring clips



FPI300172



FPI200073



Modèle	Boîte carton 12 pces / Carton box 12 pces	Sachet LS / Hanging pouch
Model	UV / PCB	UV / PCB
20 mm Ecartement 10 mm	FPI200073 1 / 12	12 pincettes - FPI200172 10 / 200
30 mm Ecartement 15 mm	758322 1 / 12	6 pincettes - FPI300172 10 / 200
50 mm Ecartement 25 mm	FPI500073 1 / 12	4 pincettes - FPI500172 10 / 200
60 mm Ecartement 35 mm	FPI600073 1 / 12	2 pincettes - FPI600172 10 / 200
70 mm Ecartement 40 mm	FPI700073 1 / 12	2 pincettes - FPI700172 10 / 100

Pinces "spring clip" / Chrome-plated "spring clip" binder clips



FPI000172

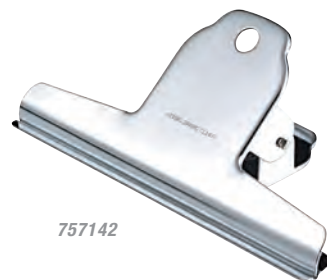

757142



Modèle	Boîte carton 12 pces / Carton box 12 pces	Sachet LS / Hanging pouch
Model	UV / PCB	UV / PCB
100 mm	FPI000073 1 / 12	2 pinces - FPI000172 10 / 200
144 mm	757142 1 / 12	1 pince - FPI040172 10 / 200

ANNEAUX BRISÉS / LOOSE-LEAF RINGS

Métal
Metal

Pour l'archivage de feuillets perforés ou listings
For archiving punched sheets or listings



FFI020272



Modèle	Boîte carton / Carton box	Sachet LS / Hanging pouch
Model	UV - SPCB	UV / PCB
ø 14 mm	-	15 pces - FFI020072 1 / 300
ø 25 mm	100 pces - 749251 1 - 30	10 pces - FFI020272 1 / 300
ø 30 mm	100 pces - FFI020373 1 - 40	10 pces - FFI020472 1 / 200
ø 64 mm	25 pces - FFI020573 1 - 60	5 pces - FFI020672 1 / 150

DOIGTIERS HÉRISSEON / THIMBLETTES

Sachet de 12 doigtiers
Pouch of 12 thimblettes



GEX000003

GEX100003

GEX110003

GEX120003



Modèle	Réf.	Conditionnement	UV	PCB
Model	Ref.	Packing		
ø 15 mm n°00				
■	GEX000003	Sachet de 12 / Pouch of 12 pces	1	250
ø 17 mm n°0				
■	GEX100003	Sachet de 12 / Pouch of 12 pces	1	250
ø 19 mm n°1				
■	GEX110003	Sachet de 12 / Pouch of 12 pces	1	250
ø 21 mm n°2				
■	GEX120003	Sachet de 12 / Pouch of 12 pces	1	250



BRACELETS CAOUTCHOUC / RUBBER BANDS

Bracelets caoutchouc blond

/ Rubber bands

Boîte carton 100 gr
/ Carton box 100 gr

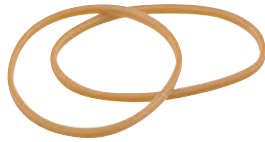

FEL040002



Sachet 1 kg
/ Pouch 1 kg



FEL120202



Modèle	Boîte carton 100 g / Carton box	Sachet 1 kg / Pouch
Model	UV 10 / PCB 100	UV 1 / PCB 10
Standard / Standard		
40 mm	FEL040002	FEL040103
60 mm	FEL060002	FEL060103
80 mm	FEL080002	FEL080103
100 mm	FEL100002	FEL100103
120 mm	FEL120002	FEL120103
150 mm	FEL150002	FEL150103
180 mm	FEL180002	FEL180103
200 mm	FEL200002	FEL200103

Modèle	Boîte carton 100 g / Carton box	Sachet 1 kg / Pouch
Model	UV 10 / PCB 100	UV 1 / PCB 10
Bande étroite / Narrow rubber bands		
70 x 5 mm	FEL070002	FEL070103
90 x 6 mm	FEL090002	FEL090103
100 x 8 mm	FEL100202	FEL100303
110 x 8 mm	FEL110002	FEL110103
150 x 6 mm	FEL150202	FEL150303
Bande large / Large rubber bands		
120 x 10 mm	FEL120202	FEL120303
150 x 10 mm	FEL150402	FEL150503
180 x 10 mm	FEL180202	FEL180303
200 x 10 mm	FEL200202	FEL200303
200 x 16 mm	FEL200402	FEL200503

Bracelets caoutchouc couleur

/ Coloured rubber bands



FEL000092



FEL000392



459805



Modèle	Réf.	Conditionnement	UV	PCB
Model	Ref.	Packing		
Boîte plastique Pegboardable Hanging plastic box				
15 g	FEL000092	Pegboardable	10	50
Sachet plastique / Plastic pouch				
250 g	FEL000193	Vrac / Bulk	1	40
Boîte carton Pegboardable Hanging carton box				
100 g	FEL000292	Pegboardable	10	100
50 g	FEL000392	Pegboardable	10	200
Balle d'élastiques - 4 couleurs / Rubber ball - 4 assorted colours				
ø 60 mm	459805	Pegboardable	6	96

Bracelets en croix

/ Parcel rubber bands



459132

Modèle	Réf.	Conditionnement	UV	PCB
Model	Ref.	Packing		
Sachet de 10 / Pouch of 10				
190 mm	459102	Vrac / Bulk	1	120
Sachet de 25 / Pouch of 25				
160 mm	459122	Vrac / Bulk	1	120
190 mm	459132	Vrac / Bulk	1	100

COLLES / GLUES

Bâtons de colle / Glue sticks

Sans solvant

Solvent free

Papier, carton, photos...

For paper, cardboard, photos...



342112 x 24 pces



342112



342122



342142

Modèle	Réf.	Conditionnement	UV	PCB
Model	Ref.	Packing		
10 gr	342112	Boîte / Box	24	576
20 gr	342122	Boîte / Box	12	288
40 gr	342142	Boîte / Box	12	144

Rollers de colle / Glue tapes

8 mm x 7 m

Permanente ou repositionnable
Permanent or removable glue tape



340005



340105

Modèle	Réf.	Conditionnement	UV	PCB
Model	Ref.	Packing		
Roller de colle permanente / Permanent glue tape				
■	340005	Pegboardable	12	144
Roller de colle repositionnable / Removable glue tape				
■	340105	Pegboardable	12	144

CORRECTEURS / CORRECTION TAPES AND FLUIDS

Correcteurs liquides / Correction fluids

Réf. FCR200021

Flacon de 20 ml
20 ml correction fluid

Pinceau d'application
Application brush



FCR200021



A base d'eau
Water-based



Modèle	Réf.	Conditionnement	UV	PCB
Model	Ref.	Packing		
Flacon correcteur 20 ml / 20 ml correction fluid				
20 ml	FCR200021	Vrac / Bulk	10	500



Rubans correcteurs / Correction tapes

Correcteurs latéraux et frontaux

Sideways and front correction tapes

Testé individuellement

Individually tested

Largeur 5 mm

Width 5 mm



FCR080102



FCR080002



FCR080102 x 12 pcs



Modèle	Réf.	Conditionnement	UV	PCB
Model	Ref.	Packing		
Correcteur latéral / Sideway correction tape				
5 mm x 8 m	FCR080002	Pegboardable	12	144
Correcteur frontal / Front correction tape				
5 mm x 8 m	FCR080102	Pegboardable	12	144

Largeur : 5 mm

Width : 5 mm

10 m



348502

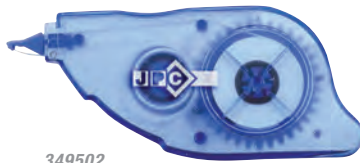

349502

Modèle	Réf.	Conditionnement	UV	PCB
Model	Ref.	Packing		
Correcteur latéral / Sideway correction tape				
5 mm x 10 m	348502	Vrac / Bulk	12	288
Correcteur frontal / Front correction tape				
5 mm x 10 m	349502	Vrac / Bulk	12	288

Mini rubans correcteurs

Mini correction tapes

Frontal

Front correction tape

Largeur 5 mm

Width 5 mm



FCR040092



FCR040092



Couleurs assorties / Assorted colours

Modèle	Réf.	Conditionnement	UV	PCB
Model	Ref.	Packing		
3 mini rubans correcteurs / 3 mini correction tapes				
5 mm x 4 m	FCR040092	Pegboardable	12	192

Ruban correcteur rétractable / Retractable correction tape

Correcteur frontal

Front correction tape

Largeur : 5 mm

Width : 5 mm



349305



349305

Couleurs assorties / Assorted colours

Modèle	Réf.	Conditionnement	UV	PCB
Model	Ref.	Packing		
Ruban correcteur rétractable / Retractable correction tape				
5 mm x 5 m	349305	Pegboardable	12	144

■ COMPAS SCOLAIRE / SCHOOL COMPASSES

Compas canon

Canon compasses

”Mon premier compas”

”My first compass”

Corps plastique

Plastic body

Bague d'adaptation

Universal holder

Livré avec 1 crayon

Comes with 1 pencil



« Pointe sécurité »



351238



FC0100063 x 25 pces



FC0100063



Couleurs assorties / Assorted colours

Modèle	Réf.	Conditionnement	UV	PCB
Model	Ref.	Packing		
	FC0100063	Vrac / Bulk	25	500
	351238	Pegboardable	25	250

Corps plastique

Plastic body

Guide à crémaillère

Tooth guide mechanism

Vis de réglage

Tightening screw

Livré avec un crayon

Comes with one pencil



351635



Modèle	Réf.	Conditionnement	UV	PCB
Model	Ref.	Packing		
	351635	Pegboardable	25	250

Coffret compas canon

/ Cased canon compass

Corps métal

Metal body

Guide à crémaillère

Tooth guide mechanism

Vis de réglage

Tightening screw

+ 1 crayon noir

+ 1 black pencil



351305

Coffret compas canon

/ Cased canon compass

Corps métal

Metal body

Guide à crémaillère

Tooth guide mechanism

Vis de réglage

Tightening screw

+ 1 crayon noir

+ 1 black pencil



FC0100272



Modèle	Réf.	Conditionnement	UV	PCB
Model	Ref.	Packing		
Canon	351305	Coffret / Case	12	288

Modèle	Réf.	Conditionnement	UV	PCB
Model	Ref.	Packing		
Canon	FC0100272	Coffret / Case	5	180



Compas mine / Lead compasses

- Corps plastique
Plastic body
- Guide à crémaillère
Tooth guide mechanism
- Vis de réglage
Tightening screw
- Livré avec un étui de mines de recharge
Comes with a case of spare leads



352435

Modèle	Réf.	Conditionnement	UV	PCB
Model	Ref.	Packing		
	352435	Pegboardable	25	250

COMPAK' compas "collège"
/ "Secondary school-compass"

- Corps métal
Metal body
- Guide à crémaillère
Tooth guide mechanism
- Vis de réglage
Tightening screw
- Pointe sécurité
Safety point
- Protection de la pointe
Protected point



FC0200073

Spécial Trousse



FC0200073 x 36 pces

Modèle	Réf.	Conditionnement	UV	PCB
Model	Ref.	Packing		
Compas en étui plastique / Compass in plastic case				
	FC0200073	Vrac / Bulk	36	216

Coffrets compas scolaire
/ School cased compasses

- Corps métal
Metal body
- Guide à crémaillère
Tooth guide mechanism
- Vis de réglage
Tightening screw
- Pointe sécurité
Safety point



352215

- + Étui de mine de recharge
+ Plastic tube with spare lead



353115

- + Taille-mine
+ Lead sharpener



355115

- + Tire-lignes / + Drawing pen
- + Manche porte-tire-ligne plastique
+ Plastic holder for drawing pen



353435

- Compas mine
- + Tire-lignes avec manche
+ Tire-lignes
- + Pointe sèche
+ Manche plastique
+ Etui de mine de recharge

Modèle	Réf.	Conditionnement	UV	PCB
Model	Ref.	Packing		
2 pces	352215	Coffret / Case	5	240
3 pces	353115	Coffret / Case	5	200
5 pces	355115	Coffret / Case	5	200
6 pces	353435	Coffret / Case	10	200

Coffret compas réversible

/ Cased reversible compass

Corps métal

Metal body

Guide à crémaillère

Tooth guide mechanism

Vis de réglage

Tightening screw

Tire-lignes métal

Metal drawing pen

1 étui de mine de rechange

1 case with spare lead



352105

Coffret compas 3 pièces

/ Cased compass 3 pieces

Corps métal

Metal body

Guide à crémaillère

Tooth guide mechanism

Vis de réglage

Tightening screw

Bague d'attache

Fastening holder

1 étui de mine de rechange

1 case with spare lead



353005

Modèle	Réf.	Conditionnement	UV	PCB
Model	Ref.	Packing		
Réversible / Reversible				
	352105	Coffret / Case	5	180

Modèle	Réf.	Conditionnement	UV	PCB
Model	Ref.	Packing		
3 pcs	353005	Coffret / Case	5	180

Coffret compas

/ Cased compass

Corps métal

Metal body

Guide à crémaillère

Tooth guide mechanism

Vis de réglage

Tightening screw

Tire-lignes métal et manche porte tire-lignes plastique

Metal drawing pen and

plastic holder for drawing pen

Pointe sèche

Compass point

1 étui de mine de rechange

1 case with spare lead

5 pcs



FC0300172

Carte de 12 mines de rechange

+ 1 taille-mine

/ Blister of 12 spare leads

+ 1 lead sharpener



FC0900062

Modèle	Réf.	Conditionnement	UV	PCB
Model	Ref.	Packing		
5 pcs	FC0300172	Coffret / Case	5	180

Modèle	Réf.	Conditionnement	UV	PCB
Model	Ref.	Packing		
	FC0900062	Pegboardable	12	300





■ **COMPAS TECHNIQUES** / TECHNICAL COMPASSES

Compas technique Eco / Eco technical compass
8 pces / 8 pces

Guide à crémaillère
Tooth guide mechanism

Vis de réglage
Tightening screw

Pointe sécurité
Safety point

Compas mine corps métal
Metal body lead compass

Tire-lignes et pointe sèche
Drawing pen and compass point

Bague d'attache
Fastening holder

Manche porte tire-lignes en plastique
Plastic holder for drawing pen

Tire-lignes métal avec manche plastique
Metal drawing pen with plastic holder

Étui de mine de rechange
Plastic tube with spare lead



8 pièces



358005

Modèle	Réf.	Conditionnement	UV	PCB
Model	Ref.	Packing		
8 pces	358005	Coffret / Case	10	100

Coffret compas balustre de précision
Cased giant precision bow compass

Métal nickelé, satiné
Satin nickerled metal

Guide à crémaillère
Tooth guide mechanism

Molette centrale à réglage micrométrique
Central wheel with micrometric adjustment

Ouverture 320 mm / Deux articulations
320 mm opening / Double articulation

Vis de réglage / Réglage rapide
Tightening screw / Rapid adjustment

Bague d'attache
Fastening holder

Adaptateur universel pour crayons, feutres et stylos
Universal adjustment for pencils, felt pens, and ballpoint pens

Etui de mine de rechange
Plastic tube with spare lead

Taille-mine
Lead sharpener



5 pces



350415

Modèle	Réf.	Conditionnement	UV	PCB
Model	Ref.	Packing		
5 pces	350415	Coffret / Case	1	60



TRAÇAGE A MÉMOIRE DE FORME / SHAPE MEMORY DRAWING INSTRUMENTS



Boutique "ELASTIKA"

Réf. 000061

10 Equerres 45° - 20 cm

20 Equerres 60° - 20 cm

10 Règles plates 30 cm

20 Double-décimètres

10 Triple-décimètres

20 Rapporteurs 180° - 12 cm

réf. 931415

réf. 931615

réf. 931345

réf. 931225

réf. 931325

réf. 931705

LA GAMME

Haute qualité
High quality

Graduation en mm gravée ineffaçable
Indelible engraved graduation in mm

Bord antitache
No-smear edge

A MÉMOIRE DE FORME FLEXIBLE

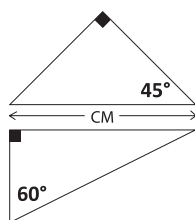

Double et triple décimètres

/ 20 and 30 cm rulers with handles

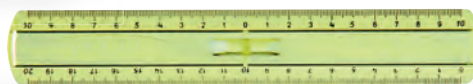

931225

Modèle	Réf.	Conditionnement	UV	PCB
Model	Ref.	Packing		
Double décimètre / 20 cm ruler with handle				
	931225	Étui / Pouch	10	200
Triple décimètre / 30 cm ruler with handle				
	931325	Étui / Pouch	10	240

Règles plates / Flat rulers



931345

Modèle	Réf.	Conditionnement	UV	PCB
Model	Ref.	Packing		
Règles plates / Flat rulers				
30 cm	931345	Étui / Pouch	10	200
50 cm	931545	Étui / Pouch	10	300

Equerres / Square sets

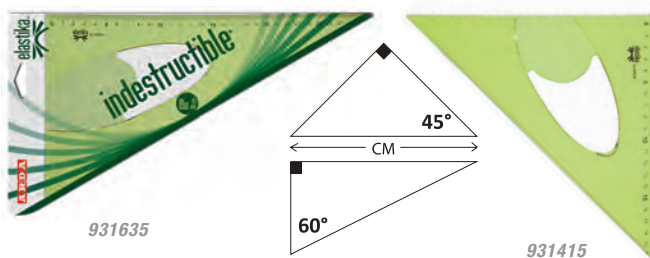

931635

931415

Modèle	Réf.	Conditionnement	UV	PCB
Model	Ref.	Packing		
45° Hypoténuse / Hypotenuse				
20 cm	931415	Étui / Pouch	10	300
30 cm	931435	Étui / Pouch	10	200
35 cm	931455	Étui / Pouch	10	140
60° Grand côté / Longest side				
20 cm	931615	Étui / Pouch	10	300
30 cm	931635	Étui / Pouch	10	200
35 cm	931655	Étui / Pouch	10	140

Rapporteurs / Protractors

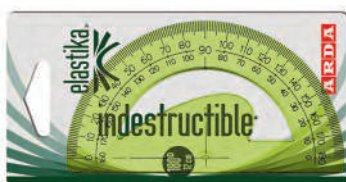

931705



931805

Modèle	Réf.	Conditionnement	UV	PCB
Model	Ref.	Packing		
Rapporteur 180° / 180° protractor				
12 cm	931705	Étui / Pouch	10	200
Rapporteur 360° / 360° protractor				
12 cm	931805	Étui / Pouch	10	360



▪ TRACAGE FANTAISIE / FANCY RULERS

Règles couleurs / Coloured rulers

1 biseau gradué en mm
1 chamfered edge graduated in mm

Bord antitache
No-smear edge

Lot de 36 règles - 16 cm
Set of 36 rulers - 16 cm

Couleurs assorties
Assorted colours

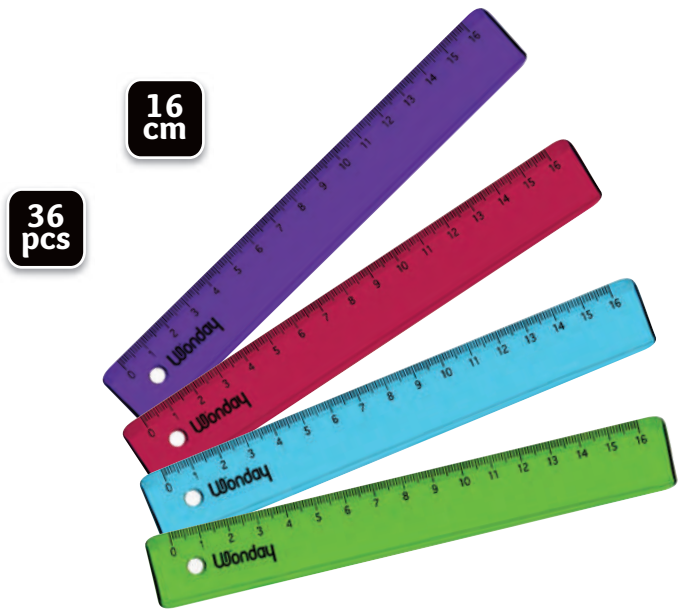

Modèle	Réf.	Conditionnement	UV	PCB
Model	Ref.	Packing		
Lot de 36 règles plates / Set of 36 flat rulers				
16 cm	FTE160093	Vrac / Bulk	1	20

Pour droitiers et gauchers
For right-handed and left-handed

2 biseaux gradués en mm
2 chamfered edges graduated in mm

Lot de 40 règles - 15 cm
Set of 40 rulers - 15 cm

Couleurs assorties
Assorted colours

40 pcs

15 cm



Une graduation pour droitiers
+ une graduation inversée spécial gaucher
partant du bord pour mesurer la hauteur



Vendu uniquement
en présentoir.

Modèle	Réf.	Conditionnement	UV	PCB
Model	Ref.	Packing		
Lot de 40 règles plates / Set of 40 flat rulers				
15 cm	000013	Vrac / Bulk	1	24

TRAÇAGE ISOLIGN INCASSABLE / SHATTERPROOF DRAWING INSTRUMENTS



Pack Traçage plastique Incassable "Isolign"

Réf. FTS900063

20 Règles plates 20 cm
20 Règles plates 30 cm
20 Règles plates 40 cm

20 Double-décimètres
20 Triple-décimètres

20 Equerres 45° - 21 cm
20 Equerres 60° - 21 cm

20 Rapporteurs 180° - 12 cm

réf. FTS200162 Offertes

réf. FTS300162

réf. FTS400162

réf. FTS220162

réf. FTS330162

réf. FTS700262

réf. FTS750362

réf. FTS850162

20 règles gratuites



Modèles déposés / Trade mark models

Règles / Rulers

Double et triple décimètres / 20 and 30 cm rulers with handle

2 biseaux gradués en mm
2 chamfered edges graduated in mm

Poignée plastique
Plastic handle



FTS220162



FTS220162

FTS330162

Modèle	Réf.	Conditionnement	UV	PCB
Model	Ref.	Packing		
Double décimètre / 20 cm ruler with handle				
	FTS220162	Pegboardable	20	200
Triple décimètre / 30 cm ruler with handle				
	FTS330162	Pegboardable	20	200

Règles plates / Flat rulers

1 biseau gradué en mm
1 chamfered edge graduated in mm

Bord antitache
No-smear edge

Modèle	Réf.	Conditionnement	UV	PCB
Model	Ref.	Packing		
Règles plates / Flat rulers				
20 cm	FTS200162	Pegboardable	20	200
30 cm	FTS300162	Pegboardable	20	200
40 cm	FTS400162	Pegboardable	20	100
50 cm	FTS500162	Pegboardable	20	100



Équerres / Square sets

- 1 biseau gradué en mm
1 chamfered edge graduated in mm
- Indication de l'angle droit
Shows right angle
- Bord antitache
No-smear edge

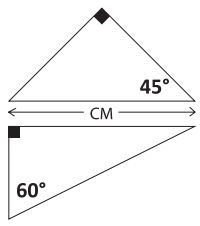

FTS750362

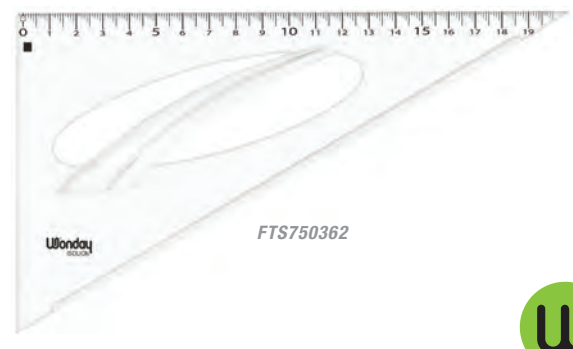

Modèle	Réf.	Conditionnement	UV	PCB
Model	Ref.	Packing		
45° Hypoténuse / Hypotenuse				
21 cm	FTS700262	Pegboardable	20	200
24 cm	FTS700362	Pegboardable	20	100
60° Grand côté / Longest side				
15 cm	FTS750262	Pegboardable	20	200
21 cm	FTS750362	Pegboardable	20	200
26 cm	FTS750462	Pegboardable	20	100

Rapporteur / Protractor

- Double graduation en degrés
Double graduation in degrees



FTS850162

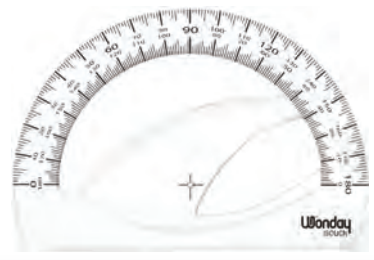

Modèle	Réf.	Conditionnement	UV	PCB
Model	Ref.	Packing		
Rapporteur 180° / 180° protractor				
12 cm	FTS850162	Pegboardable	20	200

Set Isolign Incassable

- Double décimètre
20 cm ruler with handle
- Equerres :
60° - 15 cm / Grand côté
45° - 21 cm / Hypoténuse
- Square Sets :
60° - 15 cm / Longest side
45° - 21 cm / Hypotenuse
- Rapporteur
180° - 12 cm
- 180° - 12 cm protractor



FTS040162

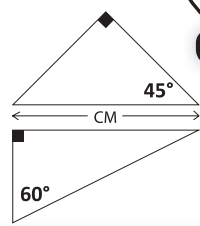

Modèle	Réf.	Conditionnement	UV	PCB
Model	Ref.	Packing		
Set Isolign				
4 pcs	FTS040162	Pegboardable	10	60

▪ TRAÇAGE INCASSABLE / SHATTERPROOF DRAWING INSTRUMENTS

Règles / Rulers

Double et triple décimètres
/ 20 and 30 cm rulers with handle

- 2 biseaux gradués en mm
2 chamfered edges graduated in mm
- Poignée plastique
Plastic handle



FTS330062

Modèle	Réf.	Conditionnement	UV	PCB
Model	Ref.	Packing		
Double décimètre / 20 cm ruler with handle				
	FTS220062	Étui / Pouch	12	720
Triple décimètre / 30 cm ruler with handle				
	FTS330062	Étui / Pouch	12	720

Règles plates
/ Flat rulers

- 1 biseau gradué en mm
1 chamfered edge graduated in mm
- Bord antitache
No-smear edge

Incassable
Shatterproof

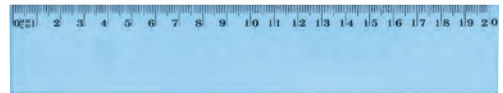

FTS200062

Modèle	Réf.	Conditionnement	UV	PCB
Model	Ref.	Packing		
Règles plates / Flat rulers				
20 cm	FTS200062	Étui / Pouch	12	720
30 cm	FTS300062	Étui / Pouch	12	720
40 cm	FTS400062	Étui / Pouch	12	360
50 cm	FTS500062	Étui / Pouch	12	360

Équerres / Square sets

- 1 biseau gradué en mm
1 chamfered edge graduated in mm

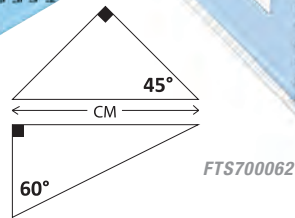
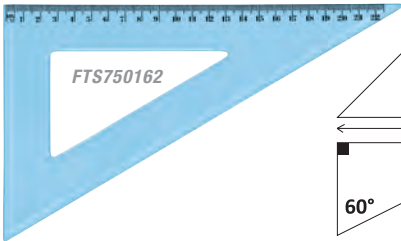
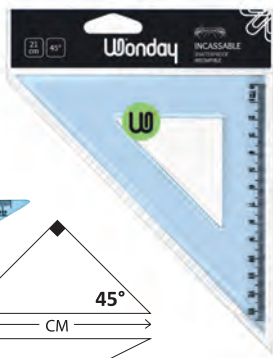

FTS700062

Modèle	Réf.	Conditionnement	UV	PCB
Model	Ref.	Packing		
45° Hypoténuse / Hypotenuse				
21 cm	FTS700062	Étui / Pouch	12	720
24 cm	FTS700162	Étui / Pouch	12	720
60° Grand côté / Longest side				
13 cm	FTS750062	Étui / Pouch	12	720
22 cm	FTS750162	Étui / Pouch	12	720

Rapporteur et Set / Protractor and Set

Set 4 pces Incassable

- Règle 30 cm
30 cm ruler
- Équerres :
60° - 22 cm / Grand côté
45° - 21 cm / Hypoténuse
- Square Sets :
60° - 22 cm / Longest side
45° - 21 cm / Hypotenuse
- Rapporteur 180° - 12 cm
180° - 12 cm protractor

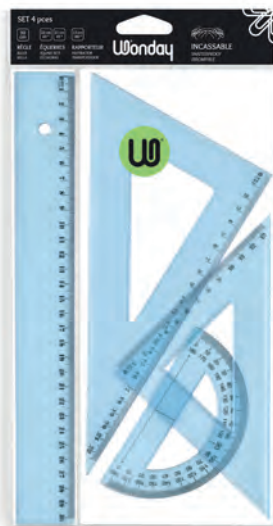

FTS040062

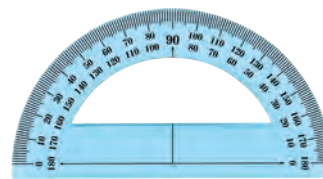

FTS850062

Rapporteur / Protractor

- Double graduation en degrés
Double graduation in degrees

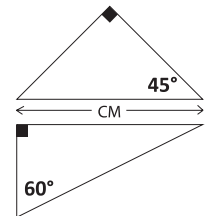

Modèle	Réf.	Conditionnement	UV	PCB
Model	Ref.	Packing		
Rapporteur 180° - 12 cm / 180° - 12 cm protractor				
	FTS850062	Étui / Pouch	24	1200
Set incassable / Shatterproof set				
4 pces	FTS040062	Pegboardable	12	144



■ TRAÇAGE CLASSIQUE / CLASSICAL DRAWING INSTRUMENTS

Règles / Rulers

Double et triple décimètres
/ 20 and 30 cm rulers with handle

- 2 biseaux gradués en mm
2 chamfered edges graduated in mm
- Poignée plastique
Plastic handle



FTE220062

Modèle	Réf.	Conditionnement	UV	PCB
Model	Ref.	Packing		
Double décimètre / 20 cm ruler with handle				
	FTE220062	Étui / Pouch	12	720
Triple décimètre / 30 cm ruler with handle				
	FTE330062	Étui / Pouch	12	720

Règles plates
/ Flat rulers

- 1 biseau gradué en mm
1 chamfered edge graduated in mm
- Bord antitache
No-smear edge

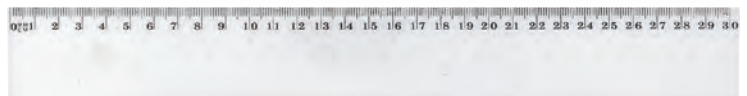

FTE300062

Modèle	Réf.	Conditionnement	UV	PCB
Model	Ref.	Packing		
Règles plates / Flat rulers				
20 cm	FTE200062	Étui / Pouch	12	720
30 cm	FTE300062	Étui / Pouch	12	720
40 cm	FTE400062	Étui / Pouch	12	360
50 cm	FTE500062	Étui / Pouch	12	360

Équerres / Square sets

- 1 biseau gradué en mm
1 chamfered edge graduated in mm



FTE750162

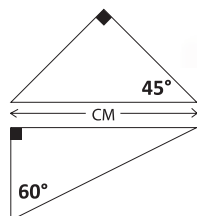

FTE700162

Modèle	Réf.	Conditionnement	UV	PCB
Model	Ref.	Packing		
45° Hypoténuse / Hypotenuse				
21 cm	FTE700062	Étui / Pouch	12	720
24 cm	FTE700162	Étui / Pouch	12	720
60° Grand côté / Longest side				
13 cm	FTE750062	Étui / Pouch	12	720
22 cm	FTE750162	Étui / Pouch	12	720

Rapporteurs et Set / Protractors and Set

Set Eco

- Règle 30 cm
30 cm ruler
- Equerres :
60° - 22 cm / Grand côté
45° - 21 cm / Hypoténuse
- Square Sets :
60° - 22 cm / Longest side
45° - 21 cm / Hypotenuse
- Rapporteur 180° - 12 cm
180° - 12 cm protractor

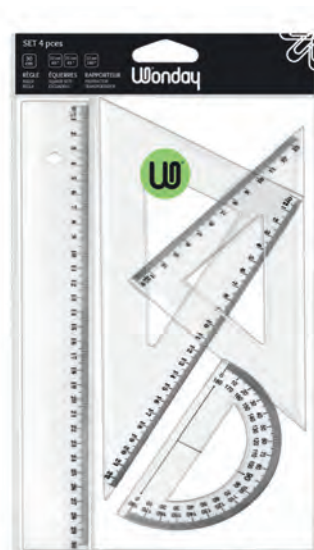

FTE040062



FTE850062

Rapporteurs / Protractors

Graduation en degrés
Graduation in degrees



FTE860062

Modèle	Réf.	Conditionnement	UV	PCB
Model	Ref.	Packing		
Rapporteur 180° - 12 cm / 180° - 12 cm protractor				
	FTE850062	Étui / Pouch	24	1200
Rapporteur 360° - 12 cm / 360° - 12 cm protractor				
	FTE860062	Étui / Pouch	24	1200
Set Eco				
4 pces	FTE040062	Pegboardable	12	144

▪ TRAÇAGE MÉTAL ALU'TECH / ALU'TECH METAL DRAWING INSTRUMENTS

LA GAMME

Graduation en mm / Aluminium anodisé
Graduation in mm / Anodised aluminium

Pour tous travaux techniques
et professionnels
For any technical and professional work

Biseaux blancs gradués
White-graduated chamfered edges

Règles / Rulers

Double et triple décimètres

/ 20 and 30 rulers with handle



910225



910325

Règles plates avec bande antidérapante

/ Flat rulers with non-skid strip



910345

Bord antitache

No-smear edge

Équerres et rapporteur

/ Square sets and protractor



917245

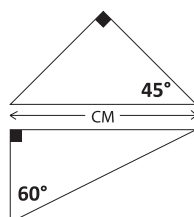

916145

Pack traçage métal ALU'TECH

Réf. 000982

10 règles plates 20 cm

10 règles plates 30 cm

10 règles plates 40 cm

10 double-décimètres

10 triple-décimètres

10 équerres 45° - 25 cm

10 équerres 60° - 25 cm

10 rapporteur 180° - 15 cm

10 règles gratuites

réf 910245 Offertes

réf 910345

réf 910445

réf 910225

réf 910325

réf 914145

réf 916145

réf 917245

Modèle	Réf.	Conditionnement	UV	PCB
Model	Ref.	Packing		
Double et triple décimètres / 20 and 30 cm rulers with handle				
Double décimètre / 20 cm ruler with handle				
	910225	Pegboardable	10	100
Triple décimètre / 30 cm ruler with handle				
	910325	Pegboardable	10	100
Règles plates avec bande antidérapante / Flat rulers with non-skid strip				
Règle 20 cm / 20 cm ruler				
	910245	Pegboardable	10	100
Règle 30 cm / 30 cm ruler				
	910345	Pegboardable	10	100
Règle 40 cm / 40 cm ruler				
	910445	Pegboardable	10	100
Règle 50 cm / 50 cm ruler				
	910545	Pegboardable	10	100
Règle 60 cm / 60 cm ruler				
	910645	Pegboardable	10	50

Modèle	Réf.	Conditionnement	UV	PCB
Model	Ref.	Packing		
Equerre 45° - Hypoténuse 25 cm / 45° square set - 25 cm hypotenuse				
	914145	Pegboardable	10	100
Equerre 60° - Grand côté 25 cm / 60° square set - 25 cm longest side				
	916145	Pegboardable	10	100
Rapporteur 180° - 15 cm / 180° - 15 cm protractor				
	917245	Pegboardable	10	200



▪ TRAÇAGE MÉTAL ALUDIC / ALUDIC METAL DRAWING INSTRUMENTS

LA GAMME
 Graduation en mm
 Graduation in mm
 Aluminium anodisé
 Anodised aluminium

Règles / Rulers

Bord antitache
 No-smear edge



912245

GARANTIE
3 ANS
 YEARS
 GUARANTEE

Modèle	Réf.	Conditionnement	UV	PCB
Model	Ref.	Packing		
Règles / Rulers				
20 cm	912245	Pegboardable	10	120
30 cm	912345	Pegboardable	10	120
40 cm	912445	Pegboardable	10	120
50 cm	912545	Pegboardable	10	120

Équerres et rapporteur / Square sets and protractor



913715

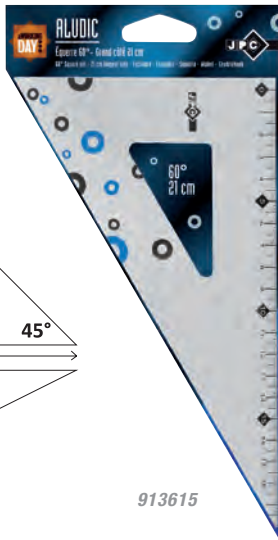
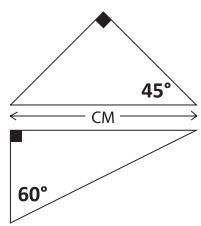

913615



913415

Modèle	Réf.	Conditionnement	UV	PCB
Model	Ref.	Packing		
Equerre 45° - Hypoténuse 21 cm / 45° square set - 21 cm hypotenuse				
	913415	Pegboardable	10	240
Equerre 60° - Grand côté 21 cm / 60° square set - 21 cm longest side				
	913615	Pegboardable	10	240
Rapporteur 180° - 15 cm / 180° - 15 cm protractor				
	913715	Pegboardable	10	240

Set / Set

Set Aludic
 Règle 30 cm
 30 cm ruler
 Equerre 60° - 21 cm
 60° - 21 cm square set
 Rapporteur 180° - 15 cm
 180° - 15 cm protractor



913908

Modèle	Réf.	Conditionnement	UV	PCB
Model	Ref.	Packing		
Set Aludic	913908	Pegboardable	10	60

▪ TRAÇAGE TECHNIQUE / TECHNICAL DRAWING

Équerre-rapporteurs / Protractor-square sets

Base 15 cm / 15 cm basis

Rapporteur incorporé 180°
Incorporated 180° protractor



965145

Modèle	Réf.	Conditionnement	UV	PCB
Model	Ref.	Packing		
Base 15 cm / 15 cm basis				
	965145	Pegboardable	20	100

Base 24 cm / 24 cm basis

Echelle opposée 180° - 0°
180° - 0° opposite scale

Traits à 45° et 135°
45° et 135° marks

Graduation en mm pour tracer des parallèles
Graduation in mm to draw parallels

Poignée détachable
Detachable handle

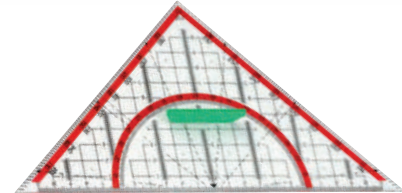

FTT700362

Modèle	Réf.	Conditionnement	UV	PCB
Model	Ref.	Packing		
Base 24 cm / 24 cm basis				
	FTT700362	Pegboardable	20	100

Pistolets à dessin / French curves

Polystyrène transparent fumé
Smoked transparent polystyrene

Pochette de 3 pièces
Wallet of 3 pieces

Courbes usuelles
Usual shapes

130 mm, 170 mm, 300 mm
130 mm, 170 mm, 300 mm



FTN000062

Modèle	Réf.	Conditionnement	UV	PCB
Model	Ref.	Packing		
Pochette 3 pièces / Wallet of 3 pieces				
	FTN000062	Pegboardable	10	100

Règles de coupe / Cutting rulers

Pour traçage et coupe
Drawing and cutting functions

Aluminium anodisé
Anodised aluminium

Bande de caoutchouc antidérapante,
bord de coupe en acier inoxydable
Anti-slip rubber surface, stainless steel cutting edge



FTT300271



Modèle	Réf.	Conditionnement	UV	PCB
Model	Ref.	Packing		
Règles de coupe / Cutting rulers				
30 cm	FTT300271	Étui / Pouch	1	10
40 cm	FTT400271	Étui / Pouch	1	10
50 cm	FTT500271	Étui / Pouch	1	10
60 cm	FTT600271	Étui / Pouch	1	10
80 cm	FTT800271	Étui / Pouch	1	10
100 cm	FTT000271	Étui / Pouch	1	10





Trace-cercles / Circle template

De 2 à 40 mm

From 2 to 40 mm

27 cercles

27 circles

Ø pairs et impairs

Ø Both even and odd

Dimensions : 22 x 10,5 cm

Dimensions : 22 x 10,5 cm

Plastique souple avec système antitache

Flexible plastic with no-smear system

Gradué en mm / cm sur un côté

Graduated in mm / cm on one side

Incassable
Shatterproof

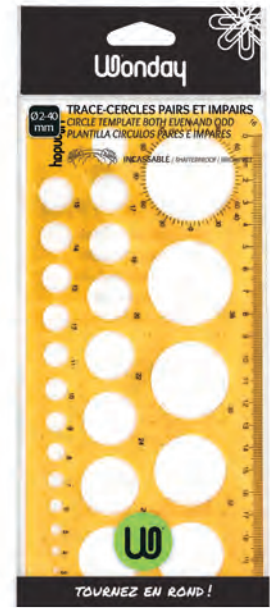

FTN050062



Modèle	Réf.	Conditionnement	UV	PCB
Model	Ref.	Packing		
Trace-cercles / Circle template				
22 x 10,5 cm	FTN050062	Pegboardable	12	144

Échelles de réduction / Reduction scales

Matière synthétique, qualité supérieure

Synthetic material, high quality

Graduations précises

Precise graduations

30 cm, triangulaire

30 cm, triangular

Gorges avec code couleur

Grooves with colour code

Etui plastique rigide

Rigid plastic case

6 combinaisons d'échelles par règle

6-scale combination per ruler



506051

506001



6 modèles repérables grâce à leur pastille de couleur

6 models identifiable thanks to their color code

Modèle	Réf.	Conditionnement	UV	PCB
Model	Ref.	Packing		
Ingénieur / Engineer 1 : 2,5 - 5 - 10 - 20 - 50 - 100				
●	506011	Boîte / Box	1	80
Architecte I / Architect I 1 : 20-25-50-75-100-125				
●	506001	Boîte / Box	1	80
Architecte II / Architect II 1 : 100-200-250-300-400-500				
●	506021	Boîte / Box	1	80
Enseignement professionnel / Professional teaching 1 : 20-25-33 1/3-50-75-100				
●	506051	Boîte / Box	1	80
Arpentage géomètre I / Land surveying I 1 : 25-50-100-200-1440-2880				
●	506041	Boîte / Box	1	80
Arpentage géomètre II / Land surveying II 1 : 500-1000-1250-1500-2000-2500				
●	506031	Boîte / Box	1	80

▪ TÈS / T-RULERS

Plastique / Plastic

Antitache - plexi
No-smear edge - plexi

Tête mobile
Moving head

Graduation gravée haute précision
High precision engraved graduation



958212

Modèle	Réf.	Conditionnement	UV	PCB
Model	Ref.	Packing		
60 cm	958212	Vrac / Bulk	1	10

Bois naturel / Natural wood

Hêtre (PEFC)
Beech wood (PEFC environmental standard)

Tête fixe (vissée et collée)
Fixed head (screwed and stuck)

Bord antitache
No-smear edge



927102



Modèle	Réf.	Conditionnement	UV	PCB
Model	Ref.	Packing		
Hêtre verni / Varnished beech wood				
60 cm	927102	Vrac / Bulk	1	50

Aluminium / Aluminium

Aluminium anodisé
Anodised aluminium

Graduation en mm
Graduation in mm

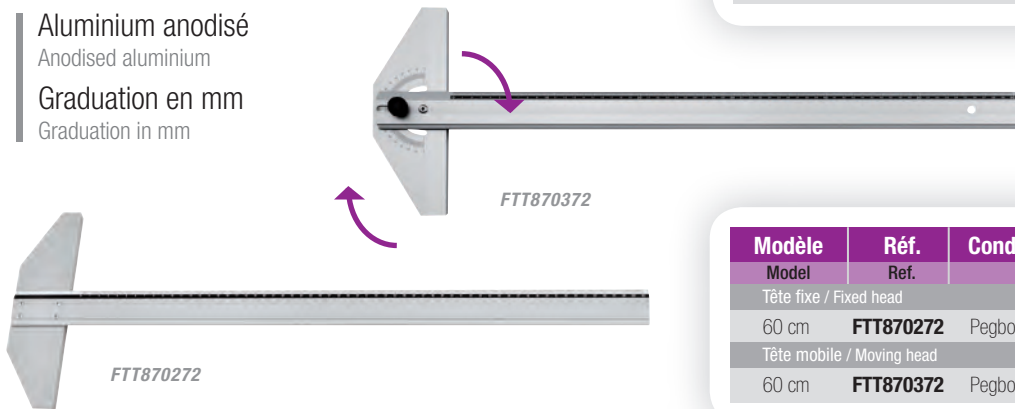

FTT870372

FTT870272



Modèle	Réf.	Conditionnement	UV	PCB
Model	Ref.	Packing		
Tête fixe / Fixed head				
60 cm	FTT870272	Pegboardable	1	30
Tête mobile / Moving head				
60 cm	FTT870372	Pegboardable	1	30

▪ ARTICLES À TABLEAU / BLACKBOARD INSTRUMENTS

Traçage bois magnétique / Magnetic wooden drawing instruments



FTA010041

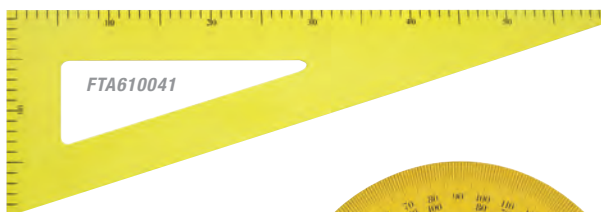

FTA610041



FTA810041



Modèle	Réf.	Conditionnement	UV	PCB
Model	Ref.	Packing		
Bois coloris jaune - Aimanté / Wood - yellow colour - Magnetized				
Règle plate 1 m avec bouton / 1 m flat ruler with knot				
	FTA010041	Vrac / Bulk	2	48
Équerre ajourée 60 cm / 60 cm square set				
	FTA610041	Vrac / Bulk	3	60
Rapporteur 180° - 35 cm avec bouton / 180° - 35 cm protractor with knot				
	FTA810041	Vrac / Bulk	3	48



Traçage bois / Wooden drawing instruments



FTA000041



FTA800041



FTA100041

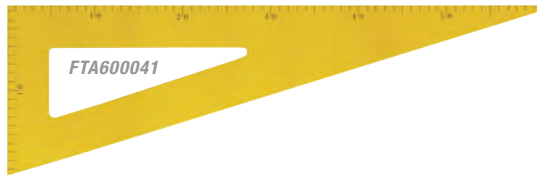

FTA600041



FTA200041



FTA250041



FTA250141

Modèle	Réf.	Conditionnement	UV	PCB
Model	Ref.	Packing		
Coloris jaune / Yellow colour				
Règle plate 1 m avec bouton / 1 m flat ruler with knot				
FTA000041		Vrac / Bulk	2	48
Équerre ajourée 60 cm / 60 cm square set				
FTA600041		Vrac / Bulk	3	60
Rapporteur 180° - 35 cm avec bouton / 180° - 35 cm protractor with knot				
FTA800041		Vrac / Bulk	3	48
Té 75 cm avec bouton / 75 cm T-ruler with knot				
FTA100041		Vrac / Bulk	2	20
Bois naturel / Natural wood				
Règle plate 1 m avec bouton / 1 m flat ruler with knot				
FTA000141		Vrac / Bulk	2	48
Compas 40 cm / 40 cm compasses				
Pointe sèche / Compass point				
Tableau	■ FTA200041	Vrac / Bulk	3	60
Avec ventouse / With suction cup				
Tableau	■ FTA250041	Vrac / Bulk	3	60
Tableau	□ FTA250141	Vrac / Bulk	3	60

Traçage plastique / Plastic drawing instruments



FTA000261



FTA800161



153612



FTA300061

Modèle	Réf.	Conditionnement	UV	PCB
Model	Ref.	Packing		
Coloris jaune / Yellow colour				
Règle plate 1 m avec poignée / 1 m flat ruler with handle				
FTA000261		Vrac / Bulk	1	50
Équerre ajourée 60 cm avec poignée / 60 cm square set with handle				
153612		Vrac / Bulk	1	50
Rapporteur 180° - 35 cm avec poignée / 180° - 35 cm protractor with handle				
FTA800161		Vrac / Bulk	1	50
Compas 35 cm / 35 cm compass				
Pointe sèche ou ventouse + adaptateur / Compass point or suction cup + adapter				
FTA300061		Vrac / Bulk	1	20

▪ RÉGLETS / FLEXIBLE RULERS

Flexibles / Flexible

Inox

Stainless steel

2 faces graduées

2 graduated sides

1 face en mm,

1 face en 1/2 mm

1 side in mm,

1 side in 1/2 mm

Réf. 500055

1 bord en mm

1 bord en 1/2 mm

sur les 2 faces

1 edge in mm,

1 edge in 1/2 mm,

on both sides

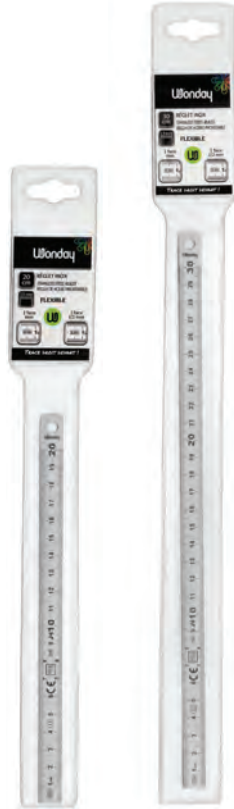

BRE200072

BRE300072



FACOM

502022



Modèle	Réf.	Conditionnement	UV	PCB
Model	Ref.	Packing		
Section 13 x 0,5 mm				
20 cm	BRE200072	Pegboardable	10	150
30 cm	BRE300072	Pegboardable	10	150
Section 20 x 0,5 mm				
50 cm	500055	Pegboardable	10	100
FACOM				
Section 13 x 0,5 mm				
15 cm	502152	Vrac / Bulk	20	160
	502155	Pegboardable	10	50
20 cm	502022	Vrac / Bulk	20	160
	502025	Pegboardable	10	50
30 cm	502032	Vrac / Bulk	20	160
	502035	Pegboardable	10	50
FACOM				
Section 20 x 0,5 mm				
50 cm	502052	Vrac / Bulk	20	140
	502055	Pegboardable	10	50

Semi-rigides / Semi-rigid

Inox

Stainless steel

Réf. BRE310072 & 504055

1 bord en mm

1 bord en 1/2 mm

sur les 2 faces

1 edge in mm,

1 edge in 1/2 mm,

on both sides

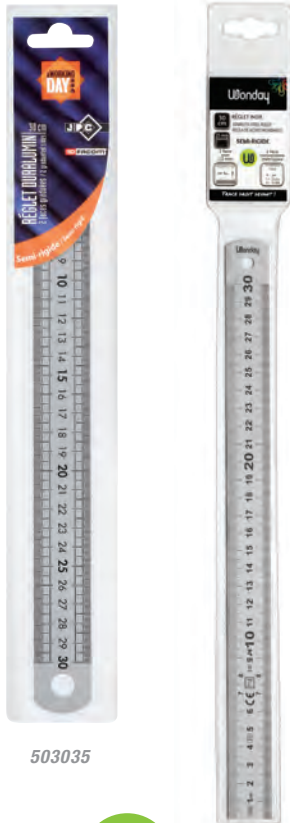

503035

BRE310072

Modèle	Réf.	Conditionnement	UV	PCB
Model	Ref.	Packing		
1 bord en mm + 1 bord en 1/2 mm sur les 2 faces				
Section 25 x 1 mm - 2 faces graduées / 2 graduated sides				
30 cm	BRE310072	Pegboardable	10	150
50 cm	504055	Pegboardable	10	50



503032

FACOM

Inox

Stainless steel

2 faces gravées :

1 bord en mm,

1 bord en 1/2 mm.

2 graduated sides:

1 edge in mm,

1 edge in 1/2 mm.

Modèle	Réf.	Conditionnement	UV	PCB
Model	Ref.	Packing		
FACOM				
Section 30 x 0,8 mm : 2 faces graduées / 2 graduated sides				
30 cm	503032	Vrac / Bulk	10	50
	503035	Pegboardable	10	50
50 cm	503052	Vrac / Bulk	10	60
	503055	Pegboardable	10	50
FACOM				
Section 30 mm x 0,8 mm				
1 face graduée / 1 graduated side				
100 cm	503102	Vrac / Bulk	1	-
150 cm	503152	Vrac / Bulk	1	-
200 cm	503202	Vrac / Bulk	1	-





■ INSTRUMENTS DE MESURE / MEASURING INSTRUMENTS

Mètres à ruban / Measuring tapes

Bi-matière = meilleure prise en main

Bi-material = comfortable handling

Clip de ceinture / 3 blocages

Belt-clip / 3 locking systems

Retour automatique

Automatic tape return

Cordon de transport

Carrying strap



507032

Modèle Model	Réf. Ref.	Conditionnement Packing	UV	PCB
3 m x 16 mm	507032	Vrac / Bulk	1	120
5 m x 19 mm	507052	Vrac / Bulk	1	120
8 m x 25 mm	507082	Vrac / Bulk	1	48
10 m x 25 mm	507012	Vrac / Bulk	1	48

Décamètres / Decameters

Ruban plastique

Plastic tape

Boîtier plastique avec crochet

Plastic box with hook

Manivelle escamotable

Removable handle



509232

Modèle Model	Réf. Ref.	Conditionnement Packing	UV	PCB
10 m	509132	Vrac / Bulk	1	50
20 m	509232	Vrac / Bulk	1	50

Thermomètres / Thermometers

Pour usages intérieur et extérieur

For indoor and outdoor use

Thermomètres plastique

Plastic thermometers

Tube en verre protégé (kérosène)

Kerosene-filled protected glass tube

T° en degrés Celsius

T° in Celsius degrees



FIM000162

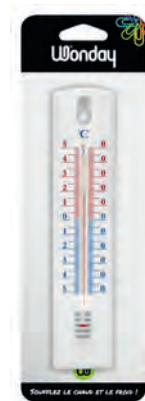

FIM000062



Modèle Model	Réf. Ref.	Conditionnement Packing	UV	PCB
195 x 42 mm	FIM000062	Pegboardable	12	288
395 x 62 mm	FIM000162	Pegboardable	6	144

■ TABLEAUX EN LIÈGE / CORK BOARDS

Cadre bois

/ Wooden frame

Fond en liège naturel, résistant et auto-cicatrisant
Self-healing, resilient natural cork

Montage à l'horizontale ou à la verticale
Can be mounted horizontally or vertically

Livré avec un kit de fixation
Wall fastening kit included

Pour le bureau et la maison
For office and home



163010



Coins bois
Wooden frame



Pour punaises et épingles
To be used with map pins and push pins
Livré avec 4 punaises
Comes with 4 pins



Modèle	Réf.	Conditionnement	UV	PCB
Model	Ref.	Packing		
Tableaux liège				
45 x 60 cm	163010	Vrac / Bulk	10	10
60 x 90 cm	163110	Vrac / Bulk	10	10

Cadre en aluminium

/ Aluminium frame

Fond en liège naturel, résistant et auto-cicatrisant
Self-healing, resilient natural cork

Montage à l'horizontale ou à la verticale
Can be mounted horizontally or vertically

Livré avec un kit de fixation
Wall fastening kit included

Pour le bureau et la maison
For office and home

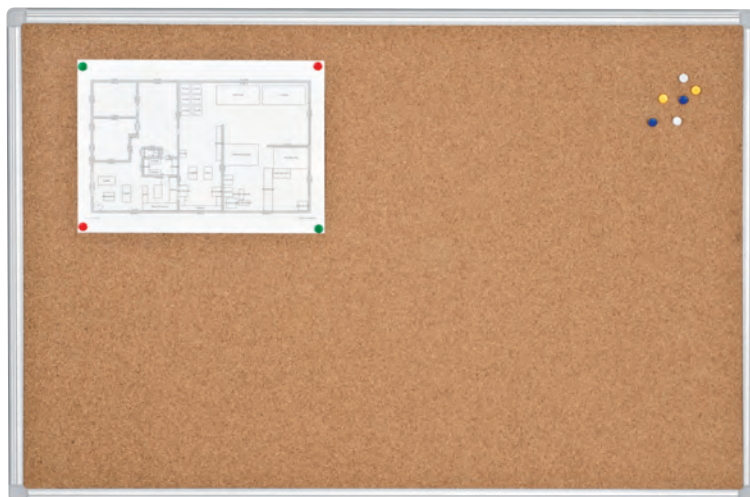

FSC100183



Coins arrondis en plastique
Plastic rounded corners

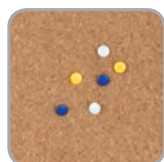

Pour punaises et épingles
To be used with map pins and push pins



Modèle	Réf.	Conditionnement	UV	PCB
Model	Ref.	Packing		
Tableaux liège				
45 x 60 cm	FSC100083	Vrac / Bulk	3	-
60 x 90 cm	FSC100183	Vrac / Bulk	3	-
90 x 120 cm	FSC100283	Vrac / Bulk	3	-



■ **TABLEAUX BLANCS MAGNÉTIQUES** / MAGNETIC WHITEBOARDS

- Cadre en aluminium anodisé
Anodised aluminium frame
- Surface lisse, blanche et effaçable à sec
Smooth dry-wipe white surface
- Montage à l'horizontale ou à la verticale
Can be mounted horizontally or vertically
- Livré avec un kit de fixation
Wall fastening kit included
- Pour le bureau et la maison
For office and home



Coins arrondis en plastique
Plastic rounded corners



Pour marqueurs et aimants
To be used with markers and magnets



Livré avec un auget
Comes with a pen tray



FSC200173



Modèle	Réf.	Conditionnement	UV	PCB
Model	Ref.	Packing		
Tableaux magnétiques blancs				
45 x 60 cm	FSC200073	Vrac / Bulk	3	-
60 x 90 cm	FSC200173	Vrac / Bulk	3	-
90 x 120 cm	FSC200273	Vrac / Bulk	3	-

■ **CHEVALET DE CONFÉRENCE - PAPERBOARD** / FLIPCHART

- 70 x 100 cm
70 x 100 cm
- Surface blanche, laquée, magnétique, inscriptible et effaçable à sec
White, lacquered, magnetic, writable and dry-wipe surface.
- 3 pieds télescopiques en métal laqué, réglable de 115 à 186 cm
3 telescopic legs stands in lacquered metal, adjustable height from 115 to 186 cm
- Système porte-bloc en plastique à crochets coulissants
Plastic clamp with width-adjustable pad hooks
- Livré sans bloc papier
Comes without paper pad
- Auget en plastique
Plastic pen tray
- Poids net : 6,10 kg
Net weight : 6,10 kg
- Sans montage
Ready for use



Modèle	Réf.	Conditionnement	UV	PCB
Model	Ref.	Packing		
70 x 100 cm	FSC400073	Vrac / Bulk	1	-

Brosse aimantée pour tableau blanc / Whiteboard magnetic eraser

Brosse aimantée pour tableau blanc
Whiteboard magnetic eraser
+ 2 marqueurs effaçables à sec
+ 2 drywipe markers

Gamme complète
Page 102



FSC650062



FSC650062



Modèle	Réf.	Conditionnement	UV	PCB
Model	Ref.	Packing		
	FSC650062	Pegboardable	10	80

Pochette de 4 marqueurs effaçables à sec / Set of 4 assorted drywipe markers

Effaçables à sec
Drywipe markers
Corps bi-matière
Bi-material body



302085



Modèle	Réf.	Conditionnement	UV	PCB
Model	Ref.	Packing		
■ ■ ■ ■	302085	Pegboardable	12	144

Porte-marqueurs magnétique / Magnetic pen holder

Aimant fort
Strong magnet
3 compartiments
3 compartments



809858



Modèle	Réf.	Conditionnement	UV	PCB
Model	Ref.	Packing		
■ Noir	809858	Pegboardable	12	72

Nettoyant pour tableaux blancs / Whiteboard cleaner

250 ml
250 ml
Sans solvant
Solvent free



FSC900031



Modèle	Réf.	Conditionnement	UV	PCB
Model	Ref.	Packing		
250 ml	FSC900031	Vrac / Bulk	6	48



Tableaux adhésifs en rouleau / Board wall stickers

Pour craies
To be used with chalk

Dimensions : 60 x 200 cm
Dimensions: 60 x 200 cm

Tableaux adhésifs en rouleau
Chalkboard wall stickers

Se collent sur tous supports lisses et non poreux
To be stuck on any smooth and not porous supports

Nettoyables avec un chiffon humide
Wet-wipe erasable

169102



Repositionnable

169202



Modèle Model	Réf. Ref.	Conditionnement Packing	UV	PCB
■ 60 x 200 cm	169102	Vrac / Bulk	10	40
■ 60 x 200 cm	169202	Vrac / Bulk	10	40

Pour marqueurs effaçables à sec
To be used with drywipe markers

Dimensions : 60 x 200 cm ou 100 x 200 cm
Dimensions: 60 x 200 cm or 100 x 200 cm

Tableau adhésif blanc en rouleau effaçable à sec
Dry-erase whiteboard wall sticker

Se colle sur tous supports lisses et non poreux
To be stuck on any smooth and not porous supports

Repositionnable

169302



Modèle Model	Réf. Ref.	Conditionnement Packing	UV	PCB
<input type="checkbox"/> 60 x 200 cm	169302	Vrac / Bulk	10	40
<input type="checkbox"/> 100 x 200 cm	FSC001013	Vrac / Bulk	1	20

■ POINTEURS LASER ET BAGUETTE TÉLESCOPIQUE / LASER AND MECHANICAL TELESCOPIC POINTERS

Avec clip
With clip

Ref. 900900 & 900901

Portée jusqu'à maximum 100 m
Maximum 100 m reach

Livré avec 2 piles AAA
Comes with 2 AAA batteries



900900



900901



900902

Corps métal
Metal body

Corps en plastique
Plastic body

Baguette télescopique
Mechanical telescopic pointer



Ref. 900902

Finition noire mate
Black matt finish

125 mm extensible jusqu'à 600 mm
125 mm (can be extended up to 600 mm)

Modèle Model	Réf. Ref.	Conditionnement Packing	UV	PCB
Pointeur laser corps en métal / Metal body laser pointer	900900	Boîte / Box	1	100
Pointeur laser corps en plastique / Plastic body laser pointer	900901	Boîte / Box	1	100
Baguette télescopique / Mechanical telescopic pointer	900902	Pegboardable	1	6

■ PORTE-BLOCS À PINCE / CLIP BOARDS



Revêtement PVC / PVC Cover

Pince métal avec plastique aux angles
Metal clip with plastic protection at corners

Oeillet de suspension rabattable
With folding hanging metal hole

Porte-stylo
Pen holder

Format 35,5 x 23,5 cm - A4 +
Size: 35.5 x 23.5 cm - F/C

Pour documents A4
For A4 documents



Modèle Model	Réf. Ref.	Conditionnement Packing	UV	PCB
■ A4 +	890052	Vrac / Bulk	1	72
■ A4 +	890062	Vrac / Bulk	1	72
■ A4 +	890072	Vrac / Bulk	1	72
■ A4 +	GPB140061	Vrac / Bulk	1	72

REF. 890402

Pour documents A3 en paysage
For horizontal A3 documents

Format 45 x 34 cm
Size: 45 x 34 cm

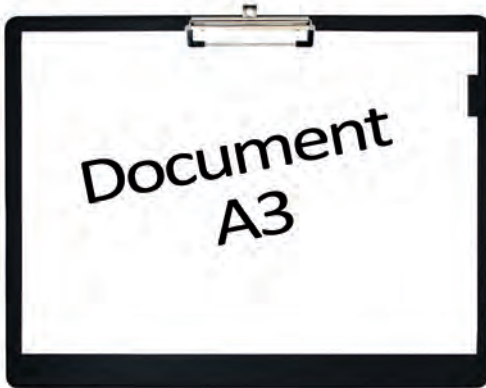

890402

REF. 890022

Porte-bloc à rabat - A4 +
Double clip-board - F/C

Format 35,5 x 23,5 cm (fermé)
Size: 35.5 x 23.5 cm (in closed position)

Pour documents A4
For A4 documents



890022

Modèle Model	Réf. Ref.	Conditionnement Packing	UV	PCB
A4 à rabat ■	890022	Vrac / Bulk	1	36
A3 paysage ■	890402	Vrac / Bulk	1	36

REF. GPB040361

Porte-bloc à pince Jumbo
Jumbo clip board

Revêtement PVC
PVC cover

Format : 32,5 x 22,5 cm
Size: 32.5 x 22.5 cm

Œillet de suspension
et porte stylo intégré
Folding hanging hole and pen holder



GPB040361



Réf. Ref.	Conditionnement Packing	UV	PCB
GPB040361	Vrac / Bulk	1	40



REF. GPB040441

Porte-bloc à pince en MDF
MDF clip board

Pour documents A4
For A4 documents

Format : 31,5 x 22,7 cm
Size: 31.5 x 22.7 cm

Ceillet de suspension rabattable
Folding hanging hole



GPB040441



Réf.	Conditionnement	UV	PCB
Ref.	Packing		
GPB040441	Vrac / Bulk	1	60

Plexi transparent / Transparent

Porte-bloc A4 plexi transparent
A4 transparent clip board

Avec crochet
With hanging metal hole

Dimensions : 31,5 x 22,5 cm
Size: 31.5 x 22.5 cm



GPB040261



Réf.	Conditionnement	UV	PCB
Ref.	Packing		
GPB040261	Vrac / Bulk	1	72

Aluminium / Aluminium

Porte-bloc Alu
Alu clip-board

Avec crochet de suspension
With hanging metal hole

Dimensions : 31,6 x 23 cm
Size: 31.6 x 23 cm



GPB040171



Réf.	Conditionnement	UV	PCB
Ref.	Packing		
GPB040171	Vrac / Bulk	1	48

Porte-bloc magnétique / Magnetic clipboard

Porte-bloc Alu avec bande magnétique
Alu clipboard with magnetic strip

Adhère aux surfaces métalliques
Adheres to metal surfaces

Avec crochet de suspension
With hanging metal hole

Dimensions : 31,6 x 23 cm
Size: 31.6 x 23 cm



890042



Réf.	Conditionnement	UV	PCB
Ref.	Packing		
890042	Vrac / Bulk	1	48

REF. GPB240061

Porte-bloc de rangement en PP avec poignée de transport
PP Storage clip board with handle

Pour documents A4
For A4 documents

Avec pinces intérieure et extérieure
et un compartiment pour stylo
With inside and outside clamps and one pen compartment.

Format : 40 x 25,5 x 5 cm
Size: 40 x 25.5 x 5 cm

Livré vide
Comes empty



GPB240061



Réf. Ref.	Conditionnement Packing	UV	PCB
GPB240061	Vrac / Bulk	1	12

■ CHEMISES, Pochettes et PROTEGE-DOCUMENTS

/ FLAP FOLDERS, WINDOW FOLDERS AND DISPLAY BOOKS

Pochettes perforées à soufflet et rabat

/ Punched bellows flap pockets

Lot de 10 pochettes PVC avec soufflet 2 cm et rabat :
Ouverture par le centre

Set of 10 punched expanding pockets with 2-cm bellow flaps:
Opening by center

Bande renforcée 11 trous

Reinforced strip 11 holes

Pour documents A4

For A4 documents



900004



Modèle Model	Réf. Ref.	Conditionnement Packing	UV	PCB
10 pces	900004	Vrac / Bulk	1	30

Pochettes coin à fenêtre

/ Window folders

Lot de 10 pochettes coin à fenêtre

Set of 10 window folders

Format 22 x 31 cm

Size 22 x 31cm

Fenêtre transparente permettant de visualiser
le document

Transparent window allowing to view the document

Faces avant et arrière effaçables, réinscriptibles
et réutilisables

All sides completely erasable, rewritable and reusable

(Breveté)

(Patented)



900802

Couleurs assorties / Assorted colours



Modèle Model	Réf. Ref.	Conditionnement Packing	UV	PCB
10 pces	900802	Vrac / Bulk	1	50



Chemises 3 rabats en PP

/ PP 3 flaps folder

Chemises polypropylène 3 rabats

Épaisseur 0,4 mm

PP 3 flaps folders - thickness 0,4 mm

Format : 32 x 24 cm

Size: 32 x 24 cm

Motifs : Points

Pattern : Dots

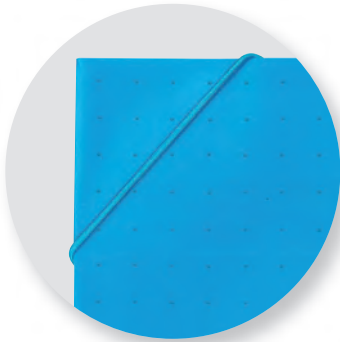

FCM400061



Modèle	Réf.	Conditionnement	UV	PCB
Model	Ref.	Packing		
Bleu	FCM400061	Vrac/ Bulk	10	120
Vert	FCM400161	Vrac/ Bulk	10	120
Jaune	FCM400261	Vrac/ Bulk	10	120
Orange	FCM400361	Vrac/ Bulk	10	120

Protège-documents à pochettes

/ Display books with pockets

Protège-documents à pochettes interchangeables

Display books with interchangeable pockets

Pochettes amovibles permettant de les ôter ou de les déplacer

Removable pockets allowing to take them out or shift them

Couverture polypropylène personnalisable

PP cover for personalized front sheet

Pour documents A4

For A4 documents

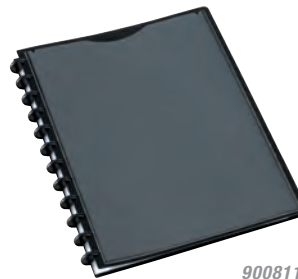

900811

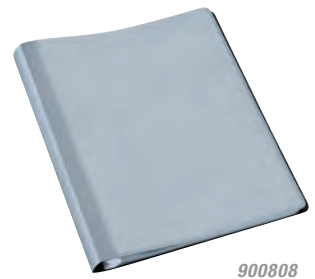

900808



Modèle	Réf.	Conditionnement	UV	PCB
Model	Ref.	Packing		
30 pochettes - 60 vues / 30 pockets - 60 slides				
	900811	Vrac / Bulk	1	36
40 pochettes - 80 vues / 40 pockets - 80 slides				
	900808	Vrac / Bulk	1	48

■ PAPIER CARBONE / CARBON PAPER

Sachet de 10 feuilles

Pouch of 10 sheets

Format A4

A4 size

Réf. APP000002 - bleu - Pour écriture manuscrite

Blue - For handwriting

Réf. APP000102 - noir - Pour machine à écrire

Black - For typewriter

APP000002



APP000102



Modèle	Réf.	Conditionnement	UV	PCB
Model	Ref.	Packing		
Bleu	APP000002	Pegboardable	12	144
Noir	APP000102	Pegboardable	12	144

■ PORTE-CARTES DE VISITE / BUSINESS CARD HOLDER

Porte-cartes de visite

Business card holder

64 pochettes - 128 cartes de visite
format international 55 x 95 mm

64 pockets - For 128 international
sized 55 x 95 mm business cards

Couverture rigide

Rigid cover



ELAMI

Réf.	Conditionnement	UV	PCB
Ref.	Packing		
64 pochettes / 64 pockets			
900310	Vrac / Bulk	6	48

■ POCLETTE PERFORÉE À SCRATCH / PUNCHED BAG WITH TOUCH FASTENER

/ PUNCHED BAG WITH TOUCH FASTENER

Pochette en PP épaisseur 20/100^{ème}

Made with PP thickness 20/100th

Fermeture à scratch

Touch fastener

Perforation 11 trous

11 holes

Porte-cartes de visite inclus

Business card holder included



FCM200061



Modèle	Réf.	Conditionnement	UV	PCB
Model	Ref.	Packing		
23,3 x 31,3 cm	FCM200061	Vrac / Bulk	10	120

■ POCNETTES ZIPPÉES / ZIPPER BAGS

Pochettes zippées en PVC renforcé

Zipper bags in reinforced PVC

Semi-transparente

Semi-transparent

Pour le courrier, les documents importants ou pour
servir de trousse en déplacement

For mail, for important documents or for using as a travel case



FCM100361

Modèle	Réf.	Conditionnement	UV	PCB
Model	Ref.	Packing		
13 x 17 cm	FCM100061	Vrac / Bulk	10	720
17,5 x 21 cm	FCM100161	Vrac / Bulk	10	480
19 x 25 cm	FCM100261	Vrac / Bulk	10	480
22 x 29 cm	FCM100361	Vrac / Bulk	10	240
26 x 34,5 cm	FCM100461	Vrac / Bulk	5	240
30 x 40 cm	FCM100561	Vrac / Bulk	5	240



POCHETTES À SCRATCH / PP DOCUMENT WALLET WITH TOUCH FASTENER

Pochettes en PP épaisseur 20/100^{ème}
Made with PP thickness 20/100^{ths}

Fermeture à scratch
Touch fastener



891012



Modèle Model	Réf. Ref.	Conditionnement Packing	UV	PCB
6,2 x 10,6 cm	891012	Vrac / Bulk	10	960
12,5 x 22,5 cm	FCM200161	Vrac / Bulk	10	480
18 x 25 cm	FCM200261	Vrac / Bulk	10	240
24 x 33,5 cm	FCM200361	Vrac / Bulk	10	120

Pochettes polypro semi-transparentes / Semi-transparent PP wallets

Présentoir de 150 pochettes en PP épaisseur 20/100^{ème}
Display of 150 wallets made with PP thickness 20/100^{ths}

Fermeture à scratch
Touch fastener

Semi-transparentes
Semi-transparent

3 tailles assorties
3 assorted sizes



000090



24 x 33,5 cm

18 x 25 cm

12,5 x 22,5 cm

5 couleurs assorties
5 assorted colours



Modèle Model	Réf. Ref.	Conditionnement Packing	UV	PCB
150 pces	000090	Boîte / Box	1	2

Modèle Model	Réf. Ref.	Conditionnement Packing	UV	PCB
12,5 x 22,5 cm				
	891702	Vrac / Bulk	10	960
	891712	Vrac / Bulk	10	960
	891722	Vrac / Bulk	10	960
	891732	Vrac / Bulk	10	960
	891742	Vrac / Bulk	10	960
18 x 25 cm				
	891752	Vrac / Bulk	10	480
	891762	Vrac / Bulk	10	480
	891772	Vrac / Bulk	10	480
	891782	Vrac / Bulk	10	480
	891792	Vrac / Bulk	10	480
24 x 33,5 cm				
	891802	Vrac / Bulk	10	240
	891812	Vrac / Bulk	10	240
	891822	Vrac / Bulk	10	240
	891832	Vrac / Bulk	10	240
	891842	Vrac / Bulk	10	240

RELIEURS D'ARCHIVES / ARCHIVING BINDERS

Relieurs d'archives en plastique

/ Plastic archiving binders

Plastique semi-rigide

Semi rigid plastic

Relieur d'archives universel

Universal archiving binder

Entraxe : 80 mm

80 mm between two legs

Capacité maximum : 7 cm

Maximum capacity : 7 cm

Livré avec la poignée
d'insertion métal.



900469

ELAMI

Modèle	Réf.	Conditionnement	UV	PCB
Model	Ref.	Packing		
50 pces	900469	Boîte / Box	1	12

Relieurs d'archives métalliques

/ Metal archiving binders

Aluminium

Aluminium

Relieur d'archives universel

Universal archiving binder

Dimensions : 8 x 5 cm, entraxe : 80 mm

Sizes : 8 x 5 cm, 80mm between two legs

Capacité maximum : 4 cm

Maximum capacity : 4 cm



900472

ELAMI

Modèle	Réf.	Conditionnement	UV	PCB
Model	Ref.	Packing		
50 pces	900472	Boîte / Box	1	100

Relieurs d'archives porte-revue

/ Archiving binders « magazine rack »

Plastique

Plastic

Porte-revue format A4

A4 archiving binder

Bande rigide avec perforation standard munie d'une fenêtre de maintien du magazine sur toute la longueur.

Rigid plastic strip with standard holes, equipped with a window maintaining the magazine on its entire length

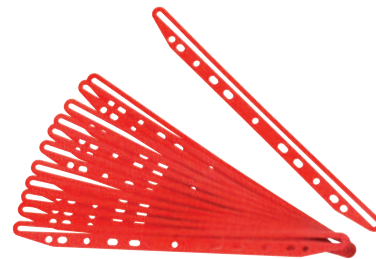

900471

ELAMI

Modèle	Réf.	Conditionnement	UV	PCB
Model	Ref.	Packing		
12 pces	900471	Vrac / Bulk	1	180



NOTES REPOSITIONNABLES / REMOVABLE STICKY NOTES

Bloc de notes repositionnables
Removable sticky notes

320 feuilles - 75 x 75 mm
320 sheets - 75 x 75 mm

4 coloris fluo assortis
4 assorted neon colours

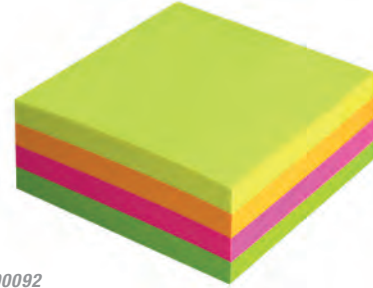

FPP100092



Réf.	Conditionnement	UV	PCB
Ref.	Packing		
FPP100092	Pegboardable	12	48

Dévidoirs de notes repositionnables / Rolling sticky notes

Rouleau dévidoir 6 cm x 10 m
6 cm x 10 m rolling notes

Notes repositionnables
Sticky notes



900109



572505



572005

Modèle	Réf.	Conditionnement	UV	PCB
Model	Ref.	Packing		
1 dévidoir de notes repositionnables / 1 rolling sticky notes				
Jaune pastel	572505	Pegboardable	12	48
Jaune fluo	572005	Pegboardable	12	48
Rose fluo	572015	Pegboardable	12	48
Orange fluo	572025	Pegboardable	12	48



900176



900175



900108



Modèle	Réf.	Conditionnement	UV	PCB
Model	Ref.	Packing		
1 dévidoir de notes repositionnables / 1 rolling sticky notes				
Jaune	900109	Boîte / Box	6	40
Pastel	900175	Vrac / Bulk	12	60
Fluo	900176	Vrac / Bulk	12	60
Lot de 10 recharges pour dévidoirs de note / Set of 10 refills				
Jaune	900108	Vrac / Bulk	1	10
Rose	900107	Vrac / Bulk	1	10

Porte-notes repositionnables

/ Removable note holders

Support A6

A6 holder

- 1 bloc 102 x 75 mm + 3 blocs 34 x 75 mm
- 1 pad 102 x 75 mm + 3 pads 34 x 75 mm
- Pastel
- Pastel

Support A5

A5 holder

- 12 blocs 34 x 75 mm
- 12 pads 34 x 75 mm
- 8 fluo + 4 pastel
- 8 fluo + 4 pastel



900154



900159

ELAMI

Modèle	Réf.	Conditionnement	UV	PCB
Model	Ref.	Packing		
Porte-notes repositionnables / Repositionable note holders				
A6	900154	Vrac / Bulk	1	54
A5	900159	Vrac / Bulk	1	40

Recharges / Refills

Lot de 5 recharges pour porte-notes A6

Set of 5 refills for A6 note holders

- Réf. 900155 : 1 bloc / pad - 102 x 75 mm + 3 blocs / pads - 34 x 75 mm - Pastel
- Réf. 900156 : 4 blocs / pads - 51 x 75 mm - Fluo
- Réf. 900157 : 6 blocs / pads - 34 x 75 mm - Pastel
- Réf. 900158 : 1 bloc / pad - 102 x 75 mm + 3 blocs / pads - 34 x 75 mm - Fluo

Lot de 5 recharges pour porte-notes A5

Set of 5 refills for A5 note holders

- Réf. 900160 : 12 blocs / pads - 34 x 75 mm 8 fluo + 4 pastel



900155



900156



900157



900158

ELAMI

Modèle	Réf.	Conditionnement	UV	PCB
Model	Ref.	Packing		
Lots de 5 recharges pour porte-notes A6 / Sets of 5 refills for A6 note holder				
5 pces	900155	Vrac / Bulk	1	8
5 pces	900156	Vrac / Bulk	1	8
5 pces	900157	Vrac / Bulk	1	8
5 pces	900158	Vrac / Bulk	1	8
Lots de 5 recharges pour porte-notes A5 / Sets of 5 refills for A5 note holder				
5 pces	900160	Vrac / Bulk	1	4

Marque-pages semi-rigides

/ Semi-rigid page markers

Marque-pages repositionnables semi-rigides

Semi-rigid removable page makers

Dimensions : 38 x 51 mm

Size: 38 x 51 mm



571505



Idéal pour le classement
Ideal for file classification

Modèle	Réf.	Conditionnement	UV	PCB
Model	Ref.	Packing		
38 x 51 mm	571505	Pegboardable	24	480



Notes repositionnables semi-transparentes

/ Semi-transparent removable sticky notes

100 feuilles PET - 75 x 75 mm

100 PET sheets - 75 x 75 mm

4 coloris fluo assortis

4 assorted neon colours

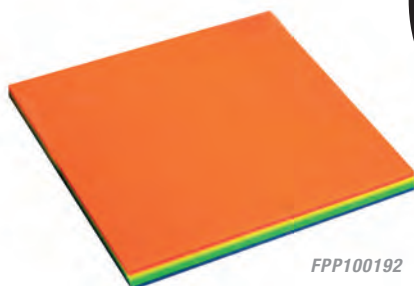

FPP100192

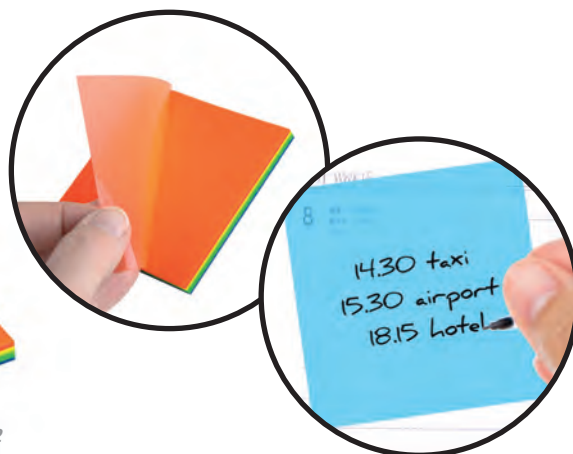

Réf.	Conditionnement	UV	PCB
Ref.	Packing		
FPP100192	Pegboardable	12	144

Marque-pages repositionnables

/ Removable page markers

Sans dévidoir / Without dispenser

Marque-pages repositionnables

étroits 12 x 44 mm

12 x 44 mm removable page markers

5 coloris fluo assortis

5 assorted neon colours

100 index

100 sheets



571005



571205

Modèle	Réf.	Conditionnement	UV	PCB
Model	Ref.	Packing		
Fluo	571005	Pegboardable	24	1152
Transparent + fluo	571205	Pegboardable	24	1152

Avec dévidoir / With dispenser

Marque-pages repositionnables

Removable page markers

5 coloris fluo assortis

5 assorted neon colours

Distributeur de 100 index

Dispenser of 100 sheets



571315



571115



Modèle	Réf.	Conditionnement	UV	PCB
Model	Ref.	Packing		
Marque-pages étroits 12 x 44 mm / 12 x 44 mm page markers				
Fluo	571015	Pegboardable	24	1008
Transparent + fluo	571215	Pegboardable	24	1008
Marque-pages standard 20 x 44 mm / 20 x 44 mm page markers				
Fluo	571115	Pegboardable	24	576
Transparent + fluo	571315	Pegboardable	24	576

Réf. 571015 & 571215

Modèles étroits : 12 x 44 mm

Narrow models: 12 x 44 mm

Réf. 571115 & 571315

Modèles standard : 20 x 44 mm

Standard models: 20 x 44 mm

■ ACCESSOIRES DE BUREAU / OFFICE ACCESSORIES

Tampons encreurs et bouteilles d'encre

/ Inking pads and ink bottles

Tampons encreurs / Inking pads

Boîtier plastique

Plastic box

Dimensions

10 x 7,5 cm

10 x 7,5 cm

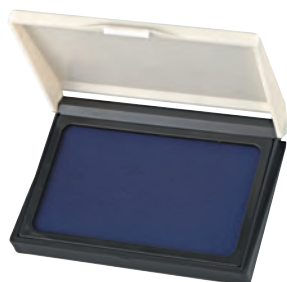

FTP200001



FTP300033



Modèle	Réf.	Conditionnement	UV	PCB
Model	Ref.	Packing		
Tampon encreur / Inking pad				
	FTP200001	Vrac / Bulk	10	240
	585122	Vrac / Bulk	5	240
	FTP200201	Vrac / Bulk	10	240
Bouteille d'encre / Ink bottle				
30 ml	FTP300033	Boîte / Box	12	360
30 ml	FTP300133	Boîte / Box	12	360
30 ml	FTP300233	Boîte / Box	12	360

Dateurs - Numéroteur

/ Date stamps - Number stamp

Bandes caoutchouc

Rubber strips

Encrage manuel

Manual inking

S'utilise avec un tampon encreur

To be used with inking pad

Numéroteur : avec sigle ./-

Number stamp : includes ./- characters



586401

1 2 3 4 5 6



587501

05 MARS 2019

Modèle	Réf.	Conditionnement	UV	PCB
Model	Ref.	Packing		
Dateur / Date stamp				
5 mm	587501	Boîte / Box	6	120
Numéroteur / Number stamp				
4 mm	586401	Boîte / Box	6	120

Mouilleur de bureau

/ Sponge damper pad

Eponge avec un support plastique

Sponge with plastic support

∅ Environ 80 mm



129518



Modèle	Réf.	Conditionnement	UV	PCB
Model	Ref.	Packing		
∅ 80 mm	129518	Pegboardable	6	240

Porte-tampons

/ Stamp racks

Support et base métal lestée

Metal weighted base and support



584901

Modèle	Réf.	Conditionnement	UV	PCB
Model	Ref.	Packing		
2 niveaux / 2 levels				
16 places	584901	Boîte / Box	1	72



Doigtiers hérissés en page 44

Thimblettes page 44



■ SOCLES POUR ÉPHÉMÉRIDES / DESK CALENDAR BASES

Bois / Wood

Bois vernis
Varnished wood

Emplacement
support crayon

Space / support for pencil



FAB100041



Modèle	Réf.	Conditionnement	UV	PCB
Model	Ref.	Packing		
Bois blanc / White wood				
Arceaux métal / Metal U-hooks				
	FAB100041	Vrac / Bulk	10	60

Plastique / Plastic

Emplacement
support crayon

Space / support for pencil



801352



Modèle	Réf.	Conditionnement	UV	PCB
Model	Ref.	Packing		
Arceaux plastique / Plastic U-hooks				
Blanc	801302	Vrac / Bulk	2	50
Rouge	801322	Vrac / Bulk	2	50
Noir	801352	Vrac / Bulk	2	50
Gris	801372	Vrac / Bulk	2	50

Emplacement pour
crayon et bloc mémo
(jusqu'à 75 X 75 mm)

Space for pencil
and memo pad
(up to 75 x 75 mm)



807382

Modèle	Réf.	Conditionnement	UV	PCB
Model	Ref.	Packing		
Arceaux plastique / Plastic U-hooks				
Fumé	807382	Vrac / Bulk	2	50

■ POTS À CRAYONS PLASTIQUE / PLASTIC PENCIL CUPS



809352



809102



Modèle	Réf.	Conditionnement	UV	PCB
Model	Ref.	Packing		
ø 65 mm Hauteur 80 mm - Neutre / Height 80 mm - Plain				
Couleurs assorties / Assorted colours				
Assortis	809302	Vrac / Bulk	5	30
Rouge	809322	Vrac / Bulk	5	30
Bleu marine	809312	Vrac / Bulk	5	30
Noir	809352	Vrac / Bulk	5	30
Gris	809372	Vrac / Bulk	5	30
Verre fumé	809382	Vrac / Bulk	5	30
ø 65 mm Hauteur 80 mm - Signes du zodiaque / Height 80 mm - Zodiac				
Couleurs assorties / Assorted colours				
	809102	Vrac / Bulk	5	30

Modèle	Réf.	Conditionnement	UV	PCB
Model	Ref.	Packing		
Noir	FAB200601	Vrac / Bulk	6	192
Bleu	FAB200401	Vrac / Bulk	6	192
Jaune	FAB200101	Vrac / Bulk	6	192
Orange	FAB200201	Vrac / Bulk	6	192
Vert	FAB200001	Vrac / Bulk	6	192

■ MULTI-CASES / DESK ORGANISERS

Rotatif

Rotating

7 compartiments

7 compartments



809951

Gamme design / Design range

Matière plastique anti-choc

Shock-proof plastic material

1 emplacement mécanisme «dévidoir» pour adhésif

1 space / mechanism for tape dispenser

1 pot à crayon amovible

1 removable pencil cup

3 emplacements pour des accessoires de bureau

3 spaces for office stationery

1 emplacement pour papiers et règles

1 space for papers and rulers

Vendu vide
Comes empty



803012



Modèle	Réf.	Conditionnement	UV	PCB
Model	Ref.	Packing		
7 compartiments / 7 compartments				
Noir	■ 809951	Boîte / Box	1	36

Modèle	Réf.	Conditionnement	UV	PCB
Model	Ref.	Packing		
Bleu	■ 803012	Boîte / Box	1	10
Noir	■ 803052	Boîte / Box	1	10

■ LOUPES / MAGNIFIERS

Loupes lentille verre optique

/ Glass optical magnifiers

Lentilles en verre

Glass lenses

Grossissement x 3

X 3 magnifying power

Monture métal chromé

Chrome-plated metal frame



531751

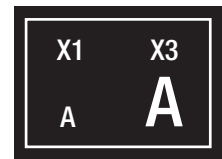

Boutique "LOUPES"

Réf. 005332

Lentille verre - monture métal chromé

6 loupes ø 50 mm

réf. 531501

6 loupes ø 60 mm

réf. 531601

4 loupes ø 75 mm

réf. 531751

3 loupes ø 90 mm

réf. 531901



Modèle	Réf.	Conditionnement	UV	PCB
Model	Ref.	Packing		
ø 50 mm	531501	Pegboardable	1	144
ø 60 mm	531601	Pegboardable	1	168
ø 75 mm	531751	Pegboardable	1	96
ø 90 mm	531901	Pegboardable	1	72

Loupes acrylique

/ Acrylic magnifiers

Grossissement x 4

X 4 magnifying power



535608



535458

Modèle	Réf.	Conditionnement	UV	PCB
Model	Ref.	Packing		
ø 45 mm	■ 535458	Pegboardable	12	144
Lentille bifocale / Bifocal lens				
ø 60 mm	■ 535608	Pegboardable	12	144



Grossissement x 3
X 3 magnifying power

Verre optique cerclé
de plastique

Plastic frame optical glass

Manche bi-matière
Bi-material handle



FLO100102



Bi-matière



Modèle	Réf.	Conditionnement	UV	SPCB
Model	Ref.	Packing		
Ø 75 mm	■ FLO100102	Pegboardable	10	100

Loupe rectangulaire éclairante

/ Rectangular illuminated magnifier

Lentille acrylique
Acrylic lens

Grossissement
principal x3 / lentille x4
X3 main magnifying
power / x4 lens

Fonctionne avec
2 piles AAA (non incluses)
Operated by 2 AAA
batteries (not included)



535011

Modèle	Réf.	Conditionnement	UV	PCB
Model	Ref.	Packing		
96 x 44 mm	■ 535011	Pegboardable	1	96

Loupes éclairantes sans bord

/ Frameless illuminated magnifiers

Lentille acrylique
Acrylic lens

Grossissement x 2,5
x 2.5 magnifying power

Manche ergonomique
Ergonomic handle

Piles incluses
Batteries included



535761



535911

Modèle	Réf.	Conditionnement	UV	PCB
Model	Ref.	Packing		
Ø 75 MM	■ 535761	Vrac / Bulk	1	10
Ø 90 MM	■ 535911	Vrac / Bulk	1	10

■ BADGES / BADGES

Badges à épingle

/ Name badges with safety pin

Attache épingle

Pin fastener

Plastique rigide transparent

Transparent rigid plastic

Livré avec un insert blanc

Comes with white insert



GID100162



583460

Modèle	Réf.	Conditionnement	UV	PCB
Model	Ref.	Packing		
40 x 60 mm	583460	Vrac / Bulk	100	1000
Sachet de 10 badges / Pouch of 10 badges				
40 x 60 mm	GID100162	Pegboardable	25	100

Badges à clip

/ Name badges with clip

Attache combiné clip + épingle

Combined plier + safety pin fastener

Plastique rigide transparent

Transparent rigid plastic

Livré avec un insert blanc

Comes with white insert



900260

REF. 900260

Boîte de 25 porte-badges de sécurité 2 faces

Double sided security badge holder

Avec attache métallique

With metal clip

Polypropylène semi-transparent mat

Semi-transparent PP plastic

Dimensions : 85 x 54 mm

Dimensions : 85 x 54 mm



GID200061

Modèle	Réf.	Conditionnement	UV	PCB
Model	Ref.	Packing		
91 x 57 mm	GID200061	Vrac / Bulk	50	1000
Sachet de 5 badges / Pouch of 5 badges				
91 x 57 mm	583958	Pegboardable	25	100
Boîte de 25 porte-badges / Boîte de 25 porte-badges				
25 pces	900260	Vrac / Bulk	1	40

Badges à pince

/ Name badges with plier

Attache combiné pince + épingle

Combined plier + safety pin fastener

Plastique souple transparent

Transparent supple plastic

Livré avec un insert photo

Comes with photo insert

GID300262



GID300061



Fond opaque

Opaque background

Livré avec un insert blanc

Comes with white insert



583970

Modèle	Réf.	Conditionnement	UV	PCB
Model	Ref.	Packing		
95 x 60 mm	GID300061	Vrac / Bulk	50	1000
95 x 75 mm	583970	Vrac / Bulk	50	2000
Sachet de 5 badges / Pouch of 5 badges				
95 x 60 mm	GID300262	Pegboardable	25	100
95 x 75 mm	583978	Pegboardable	25	100



Badges événementiels A6 / A6 conference badges

Boîte de 10 badges événementiels + cordons
Set of 10 conference badges + lanyards

Livrés avec inserts blancs
Comes with white inserts

Cordons avec clip de sécurité et 2 mousquetons en métal
Lanyards with safety clip and 2 metal snap hooks

A6 : 148 x 105 mm
A6 : 148 x 105 mm



GID400061



Modèle	Réf.	Conditionnement	UV	PCB
Model	Ref.	Packing		
10 pces	GID400061	Vrac / Bulk	1	36

Badges rigides / Rigid badges

Plastique rigide transparent
Transparent rigid plastic

Pour cartes 86 x 54 mm
For 86 x 54 mm cards

Lot de 50 pces avec attaches
Set of 50 pces with fasteners

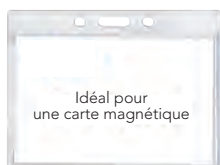

Idéal pour
une carte magnétique



900906

Modèle	Réf.	Conditionnement	UV	PCB
Model	Ref.	Packing		
50 pces	900906	Vrac / Bulk	1	20

Cordons à mousqueton / Lanyards with snap hook

Polyester
Polyester

Tour de cou avec mousqueton métal
Neck strap with snap hook

REF. GID400181

Livré avec 1 badge
100 x 60 mm

Comes with a 100 x 60 mm badge



GID400181

Clip de sécurité
sur le lacet
Safety clip



GID900021

Modèle	Réf.	Conditionnement	UV	PCB
Model	Ref.	Packing		
Avec clip / With clip				
	GID900021	Vrac / Bulk	25	600
Avec clip et boucle détachable / With clip and easily detachable badge				
	GID400181	Vrac / Bulk	25	100

Chevalet porte-nom / Table name badge

Plastique rigide transparent
Transparent rigid plastic

Livré avec un insert blanc
Comes with white insert



583040

Modèle	Réf.	Conditionnement	UV	PCB
Model	Ref.	Packing		
120 x 45 mm	583040	Vrac / Bulk	50	1000

■ OUVRE-LETTRES

/ LETTER OPENERS

Avec protection
With protection

Acier inox
Stainless steel blade

Lame 1/2 ronde
1/2 rounded blade

Manche plastique à virole
Plastic handle with ferrule



FZZ100162



582032

Modèle	Réf.	Conditionnement	UV	PCB
Model	Ref.	Packing		
21 cm	582032	Vrac / Bulk	12	120
	FZZ100162	Pegboardable	10	60

■ GRATTOIRS 2 USAGES ET FORME SCALPEL / 2 USES ERASING KNIFE AND SCALPELS

Inox Traité
Processed stainless steel blade

Manche plastique à virole
Plastic handle with ferrule



581035



581032



422012

Modèle	Réf.	Conditionnement	UV	PCB
Model	Ref.	Packing		
Grattoir à virole / Erasing knife with ferrule				
176 mm	581032	Vrac / Bulk	12	120
176 mm	581035	Pegboardable	10	60
Grattoir forme scalpel / Scalpel				
150 mm	422012	Vrac / Bulk	12	120
150 mm	422015	Pegboardable	10	60

■ SACS NAVETTES COURRIER ET SCÉLLÉS / POSTAL AND SEALED BAGS

REF. 900311

40 x 30 cm

REF. 900312

40 x 30 cm avec un soufflet de 5 cm
40 x 30 cm with a 5 cm gusset



900311



900312

ELAMI

REF. 900313

Scellés en plastique de 9 cm
9 cm plastic seals



Modèle	Réf.	Conditionnement	UV	PCB
Model	Ref.	Packing		
Sacs navettes courrier / Postal bags				
Bleu	900311	Vrac / Bulk	1	96
Vert	900312	Vrac / Bulk	1	96
Scellé / Sealed bag				
1000 pces	900313	Vrac / Bulk	1	20

■ ENVOIS RECOMMANDÉS AVEC AR

REF. 900337

Listing pour envois recommandés A4 avec AR
150 pces - Agréés par la poste française

REF. 900351

Liasses pour envois de recommandés guichet avec AR
Liasses 6 feuillets : preuve de distribution, avis de passage, souche, preuve de dépôt, avis de réception, support adhésif avec sticker AR

Dimensions 220 x 101,6 mm

100 pces - Agréés par la poste française



900351



900337

Modèle	Réf.	Conditionnement	UV	PCB
Model	Ref.	Packing		
150 pces	900337	Vrac / Bulk	1	7
100 pces	900351	Vrac / Bulk	1	1



MINI-BALANCE DE PRÉCISION / POCKET PRECISION SCALE

Format : 115 x 64 x 18 mm

Format : 115 x 64 x 18 mm

500 g, gradué par 0,1 g

500 g, graduated every 0.1 g

Résolution 0,01 g

0.01 g resolution

Fonctions tare, compteuse et auto off

Tare weight, counting and auto off functions

Livrée avec une notice

Delivered with instructions for use

Fonctionne avec 2 piles AAA 1.5 V (incluses)

Operated by 2 AAA - 1.5 V batteries (included)



610111

Modèle	Réf.	Conditionnement	UV	PCB
Model	Ref.	Packing		
	610111	Boîte / Box	1	100

PÈSE-LETTRES ET PÈSE-COLIS / LETTER AND PARCEL SCALES

Pèse-lettres / Letter scales

Terraillon. HANSON "technologie Terraillon"

Très grand afficheur LCD

Very large LCD display

2 kg, gradué par 1 g

2 kg, graduated every 1g



609231

Modèle	Réf.	Conditionnement	UV	PCB
Model	Ref.	Packing		
2 kg	609231	Boîte / Box	1	6

Tare automatique

Automatic tare weight

Capacité 5 kg, gradué par 1 g

Capacity 5 kg, graduated every 1 g

Plateau en verre ø 160 mm

Ø 160 mm glass plate

Écran LCD 50 x 22 mm

50 x 22 mm LCD display

Fonctionne avec

3 piles AAA (incluses)

Operated with 3 AAA batteries (included)



610531

Modèle	Réf.	Conditionnement	UV	PCB
Model	Ref.	Packing		
5 kg	610531	Boîte / Box	1	6

Pèse-colis / Parcel scales

Waterproof IP 65 / Tare automatique

Waterproof IP 65 / Automatic tare weight

Capacité 50 Kg, gradué par :

5 g de 0 à 15 kg

et 10 g de 15 kg à 50 kg

Capacity 50 Kg, graduated every

5 g from 0 to 15 kg

and 10 g from 15 kg to 50 kg

Plateau inox 300 x 230 mm

300 x 230 mm stainless steel plate



615001

Modèle	Réf.	Conditionnement	UV	PCB
Model	Ref.	Packing		
50 kg	615001	Boîte / Box	1	4

100 kg, gradué par 50 g

100 kg, graduated every 50 g

Adaptateur 9V fourni

9V adapter provided



610001

Modèle	Réf.	Conditionnement	UV	PCB
Model	Ref.	Packing		
100 kg	610001	Boîte / Box	1	2

Boussoles de poche

/ Pocket-size compasses

REF. 170018

Support sur aiguille
Support on needle

REF. 170028

Couvercle et
boucle d'attache
With cap and hanging ring



170028



170018



170028

Modèle	Réf.	Conditionnement	UV	PCB
Model	Ref.	Packing		
ø 35 mm	170018	Pegboardable	12	144
ø 45 mm	170028	Pegboardable	12	144

Boussoles de randonnée

/ Hiking compasses

Boîtier rigide avec couvercle
Rigid box with cap

Amortie par huile
Oil-damped

Lentille et fente de repère
Mark lens and window inside cap

Boucle d'attache
Hanging ring

Livrée avec notice et cordon
Comes with explanatory leaflet and cord



170045



170041

Modèle	Réf.	Conditionnement	UV	PCB
Model	Ref.	Packing		
ø 54 mm	170041	Vrac / Bulk	1	144
ø 54 mm	170045	Pegboardable	1	144

Boussoles d'orientation

/ Orienteering compasses

Plastique anti-choc
Shock-proof plastic

Amortie par huile
Oil-dampened

Livrée avec notice et cordon
Comes with explanatory leaflet and cord



170111



170121

Modèle	Réf.	Conditionnement	UV	PCB
Model	Ref.	Packing		
Orientation simple / Simple orientation				
60 x 85 mm	170111	Boîte / Box	1	144
Echelles de réduction imprimées, repère de direction et loupes / Printed reduction scales, direction landmarks and magnifiers				
60 x 128 mm	170121	Boîte / Box	1	50



▪ ACCESSOIRES ÉLECTRIQUES / ELECTRICAL ACCESSORIES

Cordons prolongateurs / Extension leads

Norme NF

NF French standard

2 phases + terre - 10/16A

2 phases + ground - 10/16A

Avec ECLIPSES

« sécurité enfants »

With children safety shutters



630055



Modèle	Réf.	Conditionnement	UV	PCB
Model	Ref.	Packing		
Cordons prolongateurs / Extension leads				
3 m	630035	Pegboardable	1	25
5 m	630055	Pegboardable	1	20



635205



634095



633095

Modèle	Réf.	Conditionnement	UV	PCB
Model	Ref.	Packing		
3 prises sans interrupteur / 3 plugs without switch				
1 m	633095	Pegboardable	1	40
1,5 m	633195	Pegboardable	1	40
4 prises sans interrupteur / 4 plugs without switch				
1,5 m	634095	Pegboardable	1	40
4 m	634195	Pegboardable	1	20
5 prises avec interrupteur lumineux / 5-plug block with luminous switch				
1 m	635005	Pegboardable	1	30
1,5 m	635105	Pegboardable	1	30
4 m	635205	Pegboardable	1	20

Parasurtenseur protecteur parafoudre

/ Surge protector - lightning protector

5 prises parafoudre

5 lightning protector plugs

Protection fax, modem, pour matériel informatique.

Fax and modem protection, for computer hardware

Dimension du boîtier : 43 x 7 x 5,5 cm

Case dimensions : 43 x 7 x 5.5 cm

Avec interrupteur

With switch



B 7520.05



Pour organiser vos câbles, retrouvez l'EASY Scratch en page 40.

To organize your cables, please refer to our EASY Scratch p. 40.

Modèle	Réf.	Conditionnement	UV	PCB
Model	Ref.	Packing		
5 prises + câble 1,50 m / 6 plugs + cable 1,50 m				
	B 7520.05	Vrac / Bulk	1	2

▪ POCLETTE ÉTANCHE POUR SMARTPHONE / Waterproof case for smartphone

Fonction tactile préservée
Touch screen OK

Déverrouillage du bouton home possible (sauf reconnaissance des empreintes)

"home" button unlocking OK
(Except fingerprint recognition)

Livré avec un cordon
Comes with a lanyard

IPX8

Conforme à la norme IPX8
Comply with IPX8 standard



U!new



Modèle	Réf.	Conditionnement	UV	PCB
Model	Ref.	Packing		
<input type="checkbox"/> <input checked="" type="checkbox"/>	GPN100062	Pegboardable	12	240

▪ CACHE-CLÉS / KEY CAPS

Sachet de 20 cache-clés
Pouch of 20 key caps



Modèle	Réf.	Conditionnement	UV	PCB
Model	Ref.	Packing		
Sachet de 20 cache-clés / Pouch of 20 key caps				
<input checked="" type="checkbox"/>	767012	Vrac / Bulk	1	240
<input checked="" type="checkbox"/>	767022	Vrac / Bulk	1	240
<input checked="" type="checkbox"/>	767042	Vrac / Bulk	1	240
<input checked="" type="checkbox"/>	767062	Vrac / Bulk	1	240

▪ PORTE-ÉTIQUETTES / LABEL RINGS



FA62170

Ø 17 mm



Réf. 900021

Porte-clés avec porte étiquette et anneau pivotant

Key and label rings with swivelling ring

Sachet de 5 pcs
Pouch of 5 pcs

Ø 22 mm



Réf. 900022

Porte-clés avec anneau brisé

Key ring with spare ring

Sachet de 20 pcs
Pouch of 20 pcs

Ø 14 mm



Couleurs assorties / Assorted colours

ELAMI

Couleurs assorties / Assorted colours

Modèle	Réf.	Conditionnement	UV	PCB
Model	Ref.	Packing		
20 pcs	FA62170	Pegboardable	10	100

Modèle	Réf.	Conditionnement	UV	PCB
Model	Ref.	Packing		
Avec anneau pivotant / With swivelling ring				
5 pcs	900021	Pegboardable	1	500
Avec anneau brisé / With spare ring				
20 pcs	900022	Pegboardable	1	288



■ ARMOIRES À CLÉS / KEY CABINETS

Acier peinture époxy
Steel with epoxy painting

Fixation murale
Wall fixing

Fermeture à clef
Key locking



FA62171



FA62171

Modèle	Réf.	Conditionnement	UV	PCB
Model	Ref.	Packing		
200 X 160 X 75 mm				
20 clefs	FA62162	Vrac / Bulk	1	10
250 X 180 X 75 mm				
48 clefs	FA62171	Vrac / Bulk	1	6
370 X 280 X 60 mm				
80 clefs	FA62202	Vrac / Bulk	1	4
370 X 280 X 80 mm				
140 clefs	FA62207	Vrac / Bulk	1	4

■ CAISSE À MONNAIE / CASH BOXES

Acier peinture époxy
Steel with epoxy painting

Casier à monnaie : compartiment amovible,
serrure à cylindre + 2 clefs

Cash tray : removable cash compartment,
Roller-lock with 2 keys

Poignée de transport en acier nickelé
Nickel-plated carry handle



FA62137



Présentoir caisses à monnaie

Réf. **FA62100**

- 2 Caisses 160 x 125 x 80 mm Jaune **réf. FA62111**
- 3 Caisses 205 x 160 x 90 mm Bleu **réf. FA62122**
- 3 Caisses 255 x 205 x 90 mm Rouge **réf. FA62137**
- 2 Caisses 330 x 240 x 90 mm Noir **réf. FA62133**



FA62120

Modèle	Réf.	Conditionnement	UV	PCB
Model	Ref.	Packing		
160 X 125 X 80 mm				
	FA62111	Vrac / Bulk	1	18
205 X 160 X 90 mm				
	FA62122	Vrac / Bulk	1	10
255 X 205 X 90 mm				
	FA62137	Vrac / Bulk	1	8
330 X 240 X 90 mm				
	FA62133	Vrac / Bulk	1	6
Caisse à monnaie avec monnayeur EURO intégré / Cash box with integrated EURO cash tray				
250 X 180 X 90 mm				
	FA62120	Vrac / Bulk	1	8

▪ LAVETTES ET ÉPONGES / TOWELS AND SPONGES

Lavettes "micro-fibres" / "Microfiber" towels

Lavette 40 x 40 cm
40 x 40 cm towel

Lavable plus de 200 fois
Can be washed more than 200 times

280 gr/m² - 70% Polyester 30% Polyamide
280 gr/m² - 70% Polyester 30% Polyamide



159102
(Lot de 5)

Modèle	Réf.	Conditionnement	UV	PCB
Model	Ref.	Packing		
Sachet de 5 lavettes / Pouch of 5 towels				
	159102	Pegboardable	1	10

Éponge "Magique" / "Magic" sponge

Paquet de 3 éponges
Set of 3 sponges

S'utilise sans produit chimique
No need for any chemical

Humidifier légèrement et frotter doucement
Slightly moisten and gently rub

Elimine facilement les traces de feutre, de caoutchouc,
de semelles, de stylo ou de graisse, etc...

Easily eliminates smudges like felt-tip or ballpoint pen, rubber,
shoe streaks, grease...



159032
(Lot de 3)

Modèle	Réf.	Conditionnement	UV	PCB
Model	Ref.	Packing		
Lot de 3 éponges "magiques" / Set of 3 « magic » sponges				
	159032	Vrac / Bulk	1	15

Éponges / Sponges

REF. 159052

N°6

135 x 90 x 24 mm

Éponge haute qualité
High quality sponge



159052
(Lot de 10)



159042
(Lot de 10)

REF. 159042

Grattante / Scratching

130 x 90 x 26 mm

Modèle	Réf.	Conditionnement	UV	PCB
Model	Ref.	Packing		
Lot de 10 pces / Set of 10 pces				
N°6	159052	Vrac / Bulk	1	8
Grattante	159042	Vrac / Bulk	1	17

▪ ATTACHES ADHÉSIVES "TROU EUROPÉEN" / ADHESIVE HANGING TAGS WITH EURO HOLE

Pour suspendre un conditionnement
n'ayant pas de trou européen
ou pour renforcer une attache existante

For hanging a packaging with no Euro hole
or for strengthening an existing tag



830102

Modèle	Réf.	Conditionnement	UV	PCB
Model	Ref.	Packing		
Pack de 10 x 10 pces				
	830102	Vrac / Bulk	1	100



■ CADENAS / PADLOCKS

Cadenas TSA / TSA padlocks

Système TSA : Permet de sécuriser vos affaires personnelles tout en autorisant leur contrôle par les douaniers dans les aéroports.

Réf. 195504

Combinaison à 3 chiffres + câble
3-digit combination + cable

Réf. 195514

Combinaison à 4 chiffres
4-digit combination



195514



195514



195504



Modèle Model	Réf. Ref.	Conditionnement Packing	UV	PCB
Cadenas TSA à combinaison / TSA combination padlock				
Câble à 3 chiffres	195504	Pegboardable	3	96
4 chiffres	195514	Pegboardable	3	96

Cadenas métal / Metal padlocks

Combinaison à 3 chiffres
3-digit combination

Réf. 000044

4 couleurs assorties - 20 mm
4 assorted colours - 20 mm



195408

195418

195428

195438



900119



195192



195418



000044

Modèle Model	Réf. Ref.	Conditionnement Packing	UV	PCB
Cadenas à combinaison / Combination padlocks				
■ Noir 20 mm	195192	Vrac / Bulk	3	720
■ Noir 32 mm	900119	Pegboardable	3	240
■ Bleu 20 mm	195408	Pegboardable	3	144
■ Vert 20 mm	195418	Pegboardable	3	144
■ Orange 20 mm	195428	Pegboardable	3	144
■ Violet 20 mm	195438	Pegboardable	3	144
■ 24 pcs assorties	000044	Présentoir / Display	1	6

Cadenas laiton / Brass padlocks

Livré avec 3 clés
Comes with 3 keys

Cadenas laiton véritable
Solid brass padlocks

REF. 195128

Combinaison à 3 chiffres
3-digit combination



195128



195038



195048

Modèle Model	Réf. Ref.	Conditionnement Packing	UV	PCB
Cadenas à combinaison / Combination padlock				
Laiton 20 mm	195128	Pegboardable	3	144
Cadenas à clés / Padlocks + keys				
Laiton 30 mm	195038	Pegboardable	3	144
Laiton 40 mm	195048	Pegboardable	3	144

▪ GANTS / GLOVES



REF. 900137



Gants anti-coupures
Cut resistant gloves

Indice : 4543
Index : 4543

HPPE (Haute Pression Polyéthylène), enduit latex, calibrage de tissage = 13
HPPE (High Pressure Polyethylene), latex cover, weaving gauge = 13



Condit. UV PCB
Packing
Pegboardable 1 200

REF. 900138



Gants anti-dérapants
Non-slip gloves

Indice : 4131
Index : 4131

Nylon, enduit latex, calibrage de tissage = 13
Nylon, latex cover, weaving gauge = 13



Condit. UV PCB
Packing
Pegboardable 1 200

REF. 900139



Gants multi-fonctions
Multifunction gloves

Indice : 3121
Index : 3121

Paume : fibre polyester
Palm : polyester fiber
Dos : mélange de tissus élastiques et imperméables
Back : mix of elastic and waterproof materials



Condit. UV PCB
Packing
Pegboardable 1 100

▪ BOÎTES À OUTILS / TOOLBOX

Réf 900050

Boîte à outils magnétiques de précision

Professional magnetic screwdriver set

70 pièces
70 pieces

900050



⊛ CR-V T10 CR-V T15 CR-V T20 CR-V T25 CR-V T30

⊛ T-3 T-4 T-5 T-6 T-7 T-8 T-9 T-10 T-15 T-20

⊛ 1.0 1.5 2.0 2.5 3.0 3.5 4.0 CR-V5 CR-V6 CR-V7

⊛ PH00 PH0 PH1 PH2

⊛ H0.9 H1.3 H1.5 H2.0 H2.5 H3.0 H4.0

⊛ 1.5 ⊛ 2.3

⊛ 2.0 ⊛ CR-V1

⊛ 2.6



⊛ 2.5 3.0 3.5 4.0 4.5
⊛ 5.0 5.5 6.0 7.0 8.5 9.0
⊛ 10.0 11.0 12.0 13.0



Réf 900238

106 pièces : 42 outils et 64 petits accessoires
106 pieces : 42 tools and 64 small accessories



900238



Réf. Ref.	Conditionnement Packing	UV	PCB
900050	Vrac / Bulk	1	20
900238	Vrac / Bulk	1	4

▪ PENDULES MURALES / WALL CLOCKS

∅ 30 cm
∅ 30 cm

Boîtier ABS antichoc
Shockproof ABS frame

Fonctionne avec 1 pile AA/LR6-1,5V (incluse)
Operated by a AA/LR6-1,5V battery (included)

Livrée avec une notice d'instructions
Delivered with instructions for use

438001



Changement d'heure été/hiver automatique >

438002



Modèle Model	Réf. Ref.	Conditionnement Packing	UV	PCB
Quartz / Quartz	438001	Pegboardable	1	20
Radio-contrôlée / Radio-controlled (DCF)	438002	Pegboardable	1	20



■ BLOUSES BLANCHES 100 % COTON / 100% COTTON WHITE WORK COAT

Blouse blanche

White work coat

Modèle mixte

Both for men and women

Fermeture par boutons en plastique

Closure by plastic buttons

Manches longues, col tailleur

Long sleeves, open collar

3 poches : 2 poches basses et 1 poche poitrine

3 pockets: 2 low pockets and 1 chest pocket



Tissu 100% coton 240 g/m²

100% cotton fabric 240 gsm

Livré avec un cintre
Comes with a coat hanger



Col tailleur
Open collar

Emplacement stylo
Pen holder



Tissu 100% coton 190 g/m²
100% cotton fabric 190 gsm

Junior - 8/10 ans
Junior - 8/10 years



REF SEP400021

Taille XS :

A = 11,5cm
B = 52cm
C = 22 cm
D = 88 cm
E = 97 cm
F = 91 cm
G = 97 cm
H = 37,5 cm

REF SEP410021

Taille S :

A = 12,5 cm
B = 60 cm
C = 25,5 cm
D = 95 cm
E = 98 cm
F = 92 cm
G = 98 cm
H = 37 cm

REF SEP420021

Taille M :

A = 13,5 cm
B = 62 cm
C = 27 cm
D = 95 cm
E = 107 cm
F = 101 cm
G = 107 cm
H = 39 cm

REF SEP430021

Taille L :

A = 16 cm
B = 62 cm
C = 27 cm
D = 97 cm
E = 120 cm
F = 114 cm
G = 124 cm
H = 43 cm

REF SEP440021

Taille XL :

A = 17 cm
B = 63 cm
C = 29 cm
D = 100 cm
E = 128 cm
F = 122 cm
G = 134cm
H = 46 cm

REF SEP250021

JUNIOR 8 - 10 ANS :

A = 30 cm
B = 43 cm
C = 19 cm
D = 76 cm
E = 85 cm
F = 79 cm
G = 85 cm
H = 30 cm



Modèle	Réf.	Conditionnement	UV	PCB
Model	Ref.	Packing		
Coton 240 g/m ² / Cotton fabric 240 gsm				
XS	SEP400021	Vrac / Bulk	1	20
S	SEP410021	Vrac / Bulk	1	20
M	SEP420021	Vrac / Bulk	1	20
L	SEP430021	Vrac / Bulk	1	20
XL	SEP440021	Vrac / Bulk	1	20
Coton 190 g/m ² / Cotton fabric 190 gsm				
8-10 ans	SEP250021	Vrac / Bulk	1	20

Marqueur textile / Fabric marker

Encre noire indélébile

Indelible black ink

Résiste à l'eau

Water-resistant

Pour étiquettes, vêtements, blouses, etc.

For labels, clothes, work coats, etc.

Pointe fine

Fine tip



309018



Modèle	Réf.	Conditionnement	UV	PCB
Model	Ref.	Packing		
Marqueur textile / Fabric marker				
Noir / Black	309018	Pegboardable	12	144

■ CARTE MURALE / WALL MAP

Carte murale / Wall map

Carte murale du monde + drapeaux
World wall map + flags



Modèle	Réf.	Conditionnement	UV	PCB
Model	Ref.	Packing		
	963102	Boîte / Box	1	16

126 x 88 cm



963102

■ GLOBES / GLOBES

"SMALL" Ø 16 cm / "SMALL" Ø 16 cm

Ø 16 cm
Sphère bleue
Cartographie politique
Pied et méridien plastique



Modèle	Réf.	Conditionnement	UV	PCB
Model	Ref.	Packing		
Bleu	FOP500063	Boîte / Box	1	12



FOP500063

"KIDS" Ø 25 cm / "KIDS" Ø 25 cm

Ø 25cm
Sphère bleue ou rose
Globe lumineux
Cartographie simplifiée et illustrée avec de nombreux dessins représentant les populations, les monuments, la faune et la flore sur les différents continents et océans.
Pied et méridien plastique
Emballage : boîte individuelle décorée



Modèle	Réf.	Conditionnement	UV	PCB
Model	Ref.	Packing		
Bleu	464412	Boîte / Box	1	6
Rose	464912	Boîte / Box	1	6



464412



464912

Les cartographies de nos

Photos et coloris



"BASIC" Ø 25 cm / "BASIC" Ø 25 cm



Ø 25 cm
Sphère bleue
Globe lumineux avec double cartographie : Physique / Politique
Pied et méridien plastique



Modèle	Réf.	Conditionnement	UV	PCB
Model	Ref.	Packing		
Bleu	FOP550263	Boîte / Box	1	6



FOP550263

GLOBE'N'KIT Ø 30 cm / GLOBE'N'KIT Ø 30 cm



Ø 30cm
Sphère bleue
Globe lumineux avec double cartographie :
- Eteint : physique et courants marins
- Allumé : politique
Pied et méridien plastique
Livré en kit avec une notice de montage
Facilité de stockage
Emballage : boîte individuelle décorée



Montage simple en moins de 2 minutes



Modèle	Réf.	Conditionnement	UV	PCB
Model	Ref.	Packing		
Bleu	FOP551463	Boîte / Box	1	4



FOP551463

"FIRST" Ø 30 cm / "FIRST" Ø 30 cm

Ø 30cm
Globe lumineux
Pied et méridien plastique

REF FOP550363

Sphère bleue
Double cartographie : Physique / Politique

REF FOP550563

Sphère antique

REF FOP550463



Sphère bleue en RELIEF
Double cartographie : Physique / Politique



FOP550363

FOP550563

Modèle	Réf.	Conditionnement	UV	PCB
Model	Ref.	Packing		
Bleu	FOP550363	Boîte / Box	1	6
Relief	FOP550463	Boîte / Box	1	6
Antique	FOP550563	Boîte / Box	1	6



"MEDIUM" Ø 30 cm / "MEDIUM" Ø 30 cm

Ø 30cm
Globe lumineux
Pied bois et méridien plastique

REF FOP550663

Sphère bleue
Double cartographie : Physique / Politique

REF FOP550863

Sphère antique

REF FOP550763



Sphère bleue en RELIEF
Double cartographie : Physique / Politique



FOP550663

FOP550863

Modèle	Réf.	Conditionnement	UV	PCB
Model	Ref.	Packing		
Bleu	FOP550663	Boîte / Box	1	6
Relief	FOP550763	Boîte / Box	1	6
Antique	FOP550863	Boîte / Box	1	6





"PREMIUM" Ø 30 cm / "PREMIUM" Ø 30 cm

Ø 30cm
Globe lumineux
Pied bois et méridien métal

REF FOP550963

Sphère bleue
Double cartographie : Physique / Politique

REF FOP551163

Sphère antique

REF FOP551063



Sphère bleue en RELIEF
Double cartographie : Physique / Politique

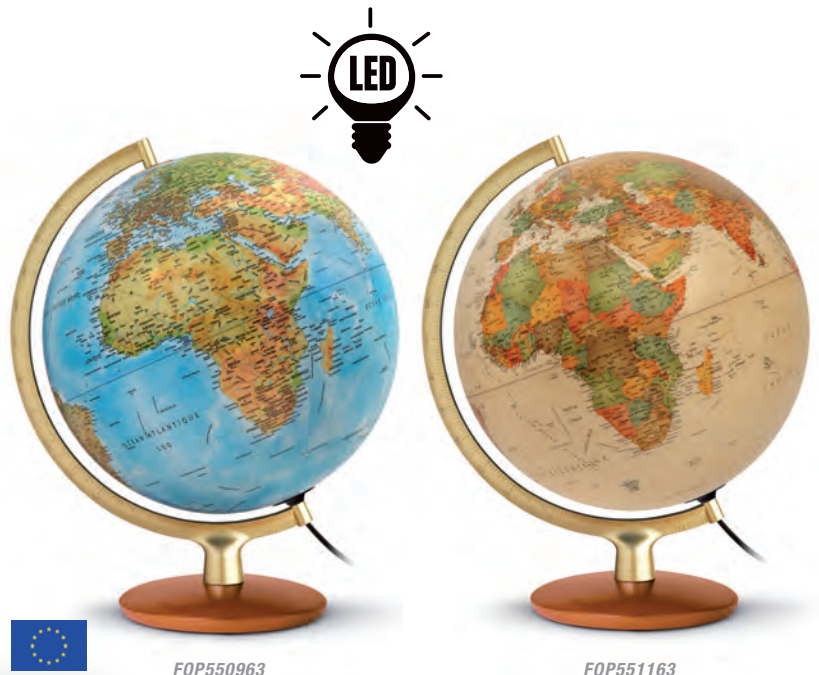

FOP550963

FOP551163



Modèle Model	Réf. Ref.	Conditionnement Packing	UV	PCB
Bleu	FOP550963	Boîte / Box	1	6
Relief	FOP551063	Boîte / Box	1	6
Antique	FOP551163	Boîte / Box	1	6



"FORTY" Ø 40 CM / "FORTY" Ø 40 CM"

Ø 40cm
Globe lumineux avec loupe
Pied bois et méridien plastique

REF FOP551263

Sphère bleue
Double cartographie : Physique / Politique

REF FOP551363

Sphère antique

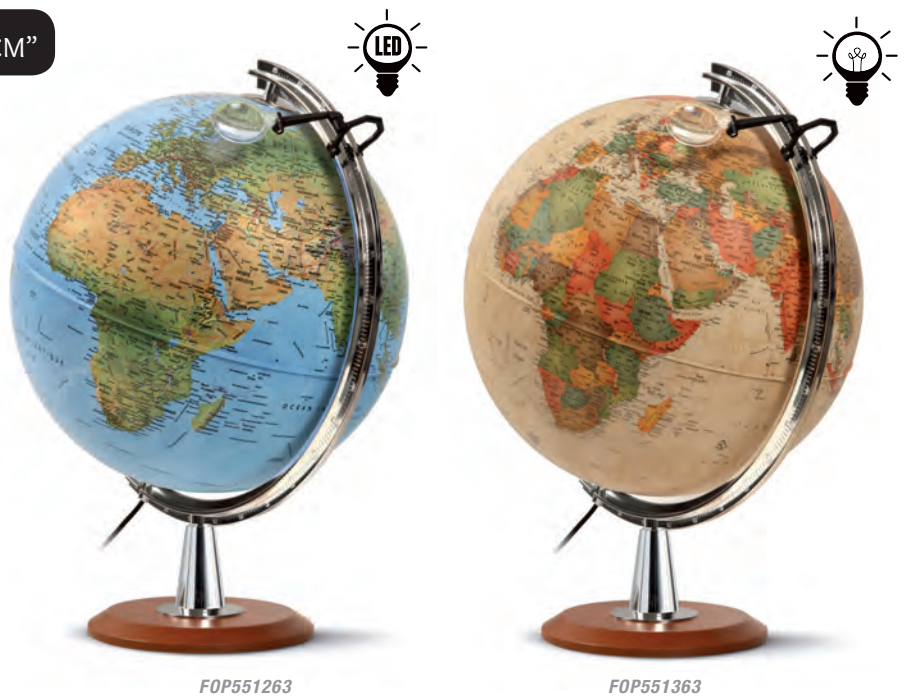

FOP551263

FOP551363



Modèle Model	Réf. Ref.	Conditionnement Packing	UV	PCB
Bleu	FOP551263	Boîte / Box	1	6
Antique	FOP551363	Boîte / Box	1	6



EDUC' ARDOISES / DRY-WIPE BOARDS



LA GAMME

Ardoises individuelles 24 x 32 cm
24 x 32 cm individual boards

Effaçables à sec et à l'eau
Dry- and water-erasable

Traitement Velleda® recto-verso
Velleda® treatment on both sides

Polypropylène recyclable
Recyclable polypropylene

Coins arrondis
Rounded corners

Modèle	Réf.	Conditionnement	UV	PCB
Model	Ref.	Packing		
Séyès + double ligne / French ruled "Seyes" + double lines	126302	Vrac / Bulk	10	140
Quadrillage + séyès / Cross-ruled + French ruled "Seyes"	126312	Vrac / Bulk	10	140
Entraînement à l'écriture / Boards alphabet	126322	Vrac / Bulk	10	140
Mesures et conversions + Quadrillage / Measures and conversion + grid pattern	126332	Vrac / Bulk	10	140

Séyès + double ligne / Graphic track

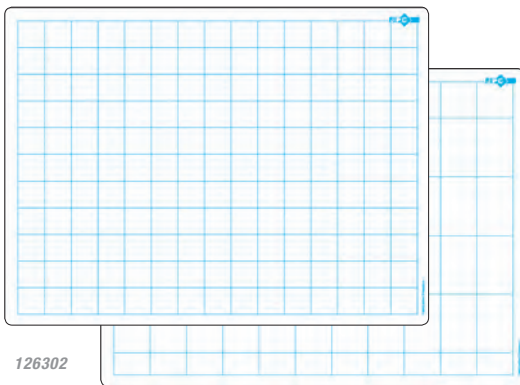

Quadrillage + Séyès / Grid pattern + "Seyès"

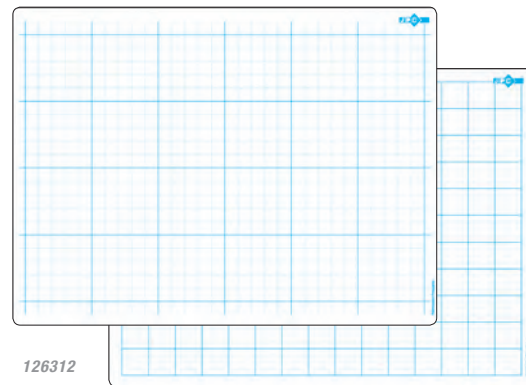

Entraînement à l'écriture / Writing training

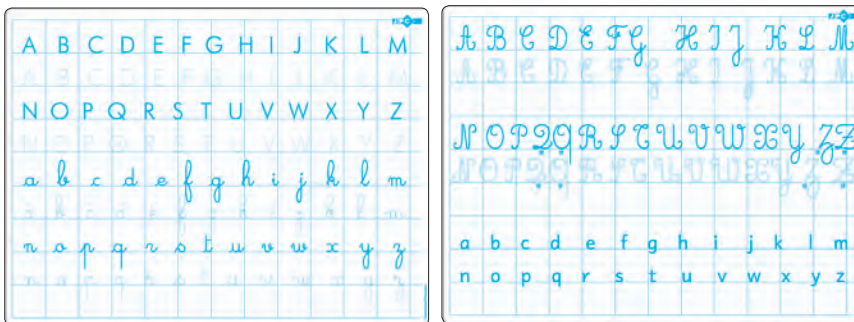

Reproduction du quadrillage Séyès avec les systèmes graphiques enseignés en maternelle et CP.

Lettres pleines, tracés en pointillés, tracés évidés, lignes vierges... pour permettre à l'élève de s'exercer en repassant sur les tracés ou à main levée.

Mesures et conversions + Quadrillage

Measures and conversion + grid pattern

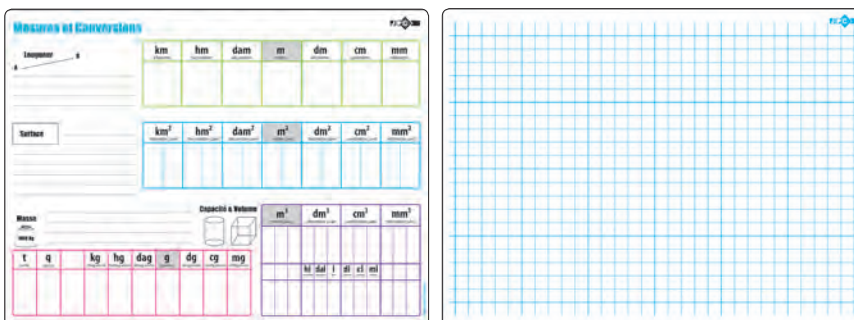



■ PANNEAUX COLLECTIFS / COLLECTIVE PANELS

LA GAMME

Revêtement effaçable à sec et à l'eau
Dry- and water-erasable

Trous européens
European holes

Coins arrondis
Rounded corners

Abécédaire / Alphabetical

70 x 100 cm



962022



Double lignes / Double lines

70 x 100 cm

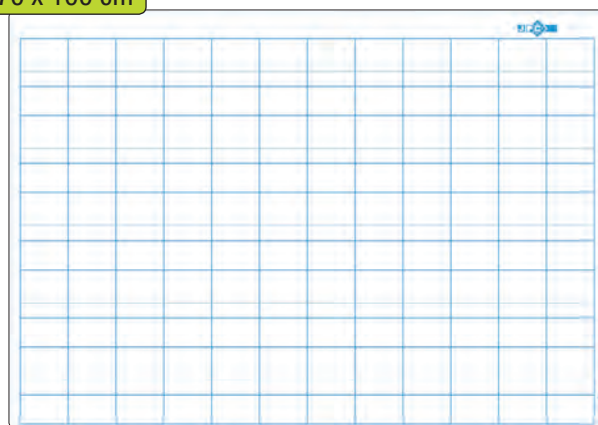

962032



Modèle	Réf.	Conditionnement	UV	PCB
Model	Ref.	Packing		
Abécédaire / Alphabetical primer				
	962022	Vrac / Bulk	1	-

Modèle	Réf.	Conditionnement	UV	PCB
Model	Ref.	Packing		
Double lignes / Double lines				
	962032	Vrac / Bulk	1	-

Séyès simple / Simple « seyes »

70 x 100 cm

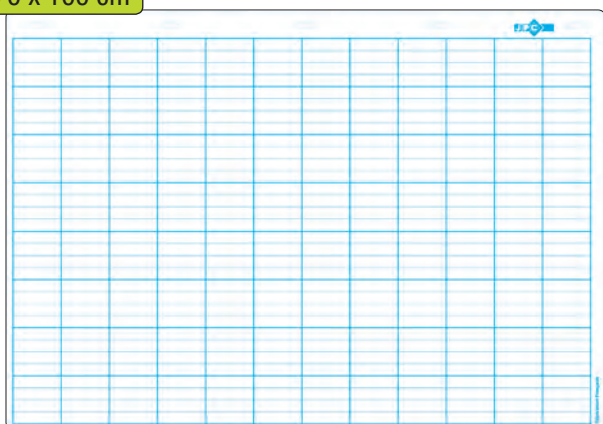

962042



Grand séyès avec marge / Big « seyes » with margin

Impression Quadri
4-colour printed

140 x 100 cm

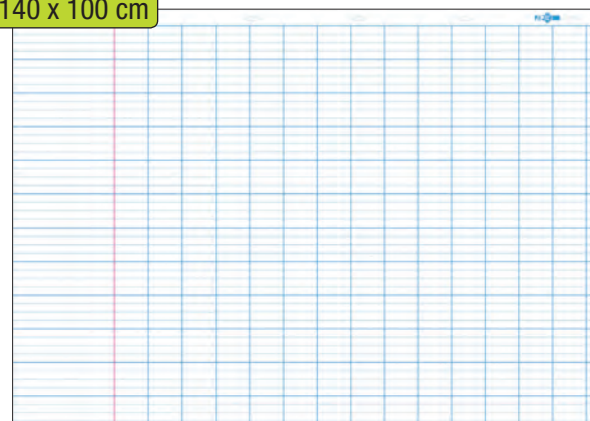

963012



Modèle	Réf.	Conditionnement	UV	PCB
Model	Ref.	Packing		
Séyès simple / Simple « seyes »				
	962042	Vrac / Bulk	1	-

Modèle	Réf.	Conditionnement	UV	PCB
Model	Ref.	Packing		
Grand séyès avec marge / Big « seyes » with margin				
	963012	Vrac / Bulk	1	-

Brosses / Erasers

Pour tableau noir / For blackboard

Non rechargeable
Non refillable



Pour tableau blanc / For whiteboard

Non rechargeable
Non refillable



FSC600141

Modèle	Réf.	Conditionnement	UV	PCB
Model	Ref.	Packing		
Feutres - corps Bois / felts - wooden body				
FSC600041		Vrac / Bulk	10	100

Modèle	Réf.	Conditionnement	UV	PCB
Model	Ref.	Packing		
Corps bois / Wooden body				
FSC600141		Vrac / Bulk	10	80

Rechargeable
Refillable



FSC650162

FSC700022

Livré avec 10 lamelles
de feutre détachables
Comes with 10 detachable
felt strips



FSC600261

Modèle	Réf.	Conditionnement	UV	PCB
Model	Ref.	Packing		
Brosse aimantée / Magnetized brush				
FSC650162		Pegboardable	12	120
Recharge 6 bandes pour brosse 156012 / 6 strips refill for brush 156012				
FSC700022		Pegboardable	12	120

Modèle	Réf.	Conditionnement	UV	PCB
Model	Ref.	Packing		
Non rechargeable / Non-refillable				
FSC600261		Vrac / Bulk	12	120

Non rechargeable
Non refillable



FSC650361

Brosse aimantée livrée avec
2 marqueurs effaçables à sec
Whiteboard magnetic eraser that comes
with 2 drywipe markers



FSC650062



Modèle	Réf.	Conditionnement	UV	PCB
Model	Ref.	Packing		
Brosse aimantée / Magnetized brush				
FSC650361		Vrac / Bulk	12	240

Modèle	Réf.	Conditionnement	UV	PCB
Model	Ref.	Packing		
Brosse aimantée pour tableau blanc (incluant 2 marqueurs effaçables à sec) / Whiteboard magnetic eraser (including 2 drywipe markers)				
FSC650062		Pegboardable	10	80



Nettoyant pour tableaux blancs / Whiteboard cleaner

250 ml
250 ml
Sans solvant
Solvent free



FSC900031



Microfibres disponibles en page 92

Modèle	Réf.	Conditionnement	UV	PCB
Model	Ref.	Packing		
250 ml	FSC900031	Vrac / Bulk	6	48

Craie / Chalk

Carbonate de calcium / Calcium carbonate

Dure plus longtemps
Longlasting writing
Facile à effacer
Easy erasing
Écriture souple
Smooth writing



368231



369131

Modèle	Réf.	Conditionnement	UV	PCB
Model	Ref.	Packing		
Craie anti-poussière / Dustless chalk				
Boîte de 100 pces / Box of 100 pces				
Blanche	<input type="checkbox"/> 368201	Boîte carton / Carton box	1	16
Assorties	368231	Boîte carton / Carton box	1	16
Bleue	<input checked="" type="checkbox"/> 368211	Boîte carton / Carton box	1	16
Rouge	<input checked="" type="checkbox"/> 368221	Boîte carton / Carton box	1	16
Verte	<input checked="" type="checkbox"/> 368241	Boîte carton / Carton box	1	16
Jaune	<input checked="" type="checkbox"/> 368261	Boîte carton / Carton box	1	16
Boîte de 10 pces / Box of 10 pces				
Blanche	<input type="checkbox"/> 368101	Pegboardable	10	160
Assorties	368131	Pegboardable	10	160

Modèle	Réf.	Conditionnement	UV	PCB
Model	Ref.	Packing		
Craie enrobée / Coated chalk				
Boîte de 100 pces / Box of 100 pces				
Blanche	<input type="checkbox"/> 369201	Boîte carton / Carton box	1	16
Assorties	369231	Boîte carton / Carton box	1	16
Bleue	<input checked="" type="checkbox"/> 369211	Boîte carton / Carton box	1	16
Rouge	<input checked="" type="checkbox"/> 369221	Boîte carton / Carton box	1	16
Verte	<input checked="" type="checkbox"/> 369241	Boîte carton / Carton box	1	16
Jaune	<input checked="" type="checkbox"/> 369261	Boîte carton / Carton box	1	16
Boîte de 10 pces / Box of 10 pces				
Blanche	<input type="checkbox"/> 369101	Pegboardable	10	160
Assorties	369131	Pegboardable	10	160

Porte-craie magnétique / Magnetized chalk holder



361002



Porte-marqueurs magnétique en page 68

Modèle	Réf.	Conditionnement	UV	PCB
Model	Ref.	Packing		
Porte-craie / Chalk holder				
	361002	Vrac / Bulk	1	500

Marqueurs à craie liquide / Chalk Markers

Marqueurs à craie liquide

Chalk markers

Sans poussière

No dust

Nettoyables avec un chiffon humide

Wet-wipe erasable

Pour tous supports lisses et non poreux

For any smooth and not porous supports



367235



367335

Corps Ø 22mm

Body Ø 22mm

Largeur d'écriture 7 à 10 mm

7 to 10 mm writing width



300002

Modèle	Réf.	Conditionnement	UV	PCB
Model	Ref.	Packing		
Marqueur à craie liquide "pointe large" / White chalk marker "large tip"				
<input type="checkbox"/> 15 gr	300002	Vrac / Bulk	6	360



367001

Modèle	Réf.	Conditionnement	UV	PCB
Model	Ref.	Packing		
Marqueur à craie liquide / White chalk marker				
<input type="checkbox"/>	367001	Vrac / Bulk	12	144
Lot de 4 - Coloris "CLASSIQUE" / Set of 4 Classic colours chalk markers				
<input type="checkbox"/> <input type="checkbox"/> <input type="checkbox"/> <input type="checkbox"/>	367235	Pegboardable	1	144
Lot de 4 - Coloris "FUN" / Set of 4 Fun colours chalk markers				
<input type="checkbox"/> <input type="checkbox"/> <input type="checkbox"/> <input type="checkbox"/>	367335	Pegboardable	1	144

■ ACCESSOIRES POUR ARDOISES / ACCESSORIES FOR INDIVIDUAL WRITING BOARDS

Crayon blanc / White pencil

Pour ardoises naturelles et bois

For natural and wooden black individual writing boards



989022

Modèle	Réf.	Conditionnement	UV	PCB
Model	Ref.	Packing		
Crayon	989022	Vrac / Bulk	12	120

Boîtiers éponge / Sponges in individual box

Pour ardoises noires

For black individual writing boards



FAR900091



FAR90192



FAR900291



Modèle	Réf.	Conditionnement	UV	PCB
Model	Ref.	Packing		
ø 70 mm - qualité supérieure / ø 70 mm - high quality erasing				
	FAR900091	Vrac / Bulk	10	120
	FAR90192	Pegboardable	10	120
ø 70 mm - synthétique / ø 70 mm - synthetic				
	FAR900291	Vrac / Bulk	10	120



Mini-brosses / Mini-brushes



FAR900542



FAR900442



Modèle	Réf.	Conditionnement	UV	PCB
Model	Ref.	Packing		
Pour ardoise naturelle / For natural slate				
	FAR900442	Pegboardable	10	50
Pour ardoise blanche / For whiteboard				
	FAR900542	Pegboardable	10	50

ARDOISES / WRITING BOARDS

Ardoises naturelles / Natural slate blackboards

Cadre en bois
Wooden frame

2 faces dont 1
quadrillée 10 x 10 mm
2 sides : 1 cross-ruled 10 x 10 mm



120119



120212



FAR100041



Modèle	Réf.	Conditionnement	UV	PCB
Model	Ref.	Packing		
18 x 26 cm	FAR100041	Vrac / Bulk	25	-
14,5 x 19 cm	120212	Vrac / Bulk	25	-
1 ardoise naturelle 18 X 26 cm / 1 Natural slate 18 X 26 cm 1 Boîtier éponge Ø 70 mm / 1 sponge Ø 70 mm 1 crayon spécial / 1 pencil				
Lot "ardoise"	120119	Pegboardable	20	-

Ardoises Noires / Blackboards

Bois / Wood

2 faces unies
2 plain sides



120410



120312

Livrée avec
2 craies

Modèle	Réf.	Conditionnement	UV	PCB
Model	Ref.	Packing		
Ardoises noires bois / Individual wooden blackboards				
Sans cadre / No frame				
20 x 25 cm	120312	Vrac / Bulk	25	-
Cadre bois / Wooden frame				
26 x 34 cm	120410	Vrac / Bulk	25	-
30 x 45 cm	120612	Vrac / Bulk	5	30
40 x 60 cm	120712	Vrac / Bulk	2	26

Plastique / Plastic

2 faces dont 1 quadrillée 10 x 10 mm
2 sides : 1 cross-ruled 10 x 10 mm



122012

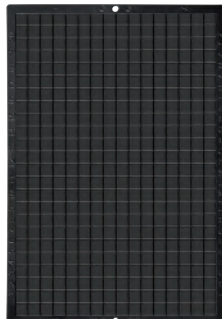

122022

Carton / Cardboard

2 faces dont 1 quadrillée rouge
2 sides : 1 red cross-ruled side

Cadre plastique couleur
Coloured plastic frame

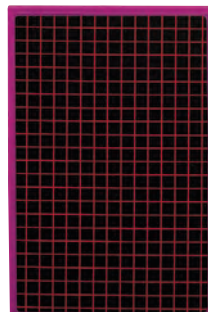

122112



122142

Modèle	Réf.	Conditionnement	UV	PCB
Model	Ref.	Packing		
Ardoises noires plastique / Individual plastic blackboards				
Cadre couleur / Coloured frame				
16 x 24 cm	122012	Vrac / Bulk	25	150
Sans cadre / No frame				
16 x 24 cm	122022	Vrac / Bulk	25	150

Modèle	Réf.	Conditionnement	UV	PCB
Model	Ref.	Packing		
Ardoises noires carton / Individual cardboard blackboards				
15,5 X 23,5 cm				
	122112	Vrac / Bulk	25	50
19 X 26 cm + anneau de suspension / Hanging ring				
	122142	Vrac / Bulk	5	25

Ardoises blanches effaçables à sec

/ Drywipe whiteboards

Cadre couleur / Coloured frame

18,5 x 26 cm

2 faces dont 1 quadrillée
2 sides : 1 plain side 1 cross-ruled

Anneau de suspension
Hanging ring

Seyes

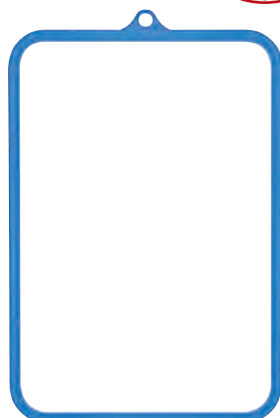

124122



FAR400162

10 x 10 mm



124012



FAR300162

Modèle	Réf.	Conditionnement	UV	PCB
Model	Ref.	Packing		
10 x 10 mm	124012	Vrac / Bulk	10	100
10 x 10 mm	FAR300162	Pegboardable	20	80
Seyes	124122	Vrac / Bulk	10	100
Seyes	FAR400162	Pegboardable	20	80



■ GOMMES / ERASERS

Gommes sans PVC / PVC-free erasers

Gomme souple protégée par un fourreau carton et cellophane
Protected with a carton sleeve and shrinkwrapped

Tout usage : pour crayon et mine graphite, idéale pour papier

All use : for pencil and graphite lead, ideal for paper

La référence = 1 gomme
Item code = 1 eraser



476312 x 36 pces



476218



476212 x 20 pces



476212

Modèle	Réf.	Conditionnement	UV	PCB
Modèle	Ref.	Packing		
Rectangle 60 x 21 x 11 mm				
	476212	Boîte / Box	20	400
Carte 1 Gomme / 1 eraser card				
	476218	Pegboardable	20	200
Rectangle 39 x 18 x 12 mm				
	476312	Boîte / Box	36	720

Rectango



474412 x 40 pces



474212



474412

Modèle	Réf.	Conditionnement	UV	PCB
Modèle	Ref.	Packing		
Rectango 20 : 42 x 28 x 10 mm				
	474212	Boîte carton / Carton box	20	400
Carte 1 gomme rectango 20 / 1 rectangular shape eraser card				
	474218	Pegboardable	20	200
Rectango 40 : 33 x 23 x 8 mm				
	474412	Boîte carton / Carton box	40	800

Ovalyne 20



Modèle	Réf.	Conditionnement	UV	PCB
Modèle	Ref.	Packing		
Ovalyne 20 : 56 x 25 x 11 mm				
	472212	Boîte carton / Carton box	20	400
Carte 1 gomme Ovalyne / 1 oval shape eraser card				
	472128	Pegboardable	20	300

Cercéo 20



472012



472012 x 20 pces

Gomme fantaisie triangulaire / Triangular fancy eraser



472102



472102 x 36 pces

Modèle	Réf.	Conditionnement	UV	PCB
Model	Ref.	Packing		
Cercéo 20 : ø 46 mm - Ep. 13 mm				
472012		Boîte carton / Carton box	20	400

Modèle	Réf.	Conditionnement	UV	PCB
Model	Ref.	Packing		
Gomme fantaisie triangulaire : 81 x 14 x 14 mm				
472102		Boîte carton / Carton box	36	720

Tandemo 40



478412



478412 x 40 pces

Gomme mie de pain

En pâte modelable

Kneadable pliable paste

Pour estomper et effacer le fusain, sanguine, crayon graphite, pastel...

For subtractive drawing techniques

To remove light charcoal or graphite marks



477012



477012 x 18 pces

Modèle	Réf.	Conditionnement	UV	PCB
Model	Ref.	Packing		
Tandemo 40 : 56 x 18 x 8 mm				
478412		Boîte carton / Carton box	40	800

Modèle	Réf.	Conditionnement	UV	PCB
Model	Ref.	Packing		
Gomme mie de pain / Kneadable eraser : 38 x 34 x 10mm				
477012		Boîte carton / Carton box	18	432

Stylo-gomme / Mechanical eraser

Stylo-gomme

Mechanical eraser



479202

Modèle	Réf.	Conditionnement	UV	PCB
Model	Ref.	Packing		
Stylo-gomme 125 x 15 x 13 mm - Couleurs assorties / Assorted colours				
Boîte carton de 12 pces / Box of 12 pces				
479202		Boîte carton / Carton box	1	16



■ COLORIAGE / COLOURING ACTIVITIES

Feutres MIN'O / MIN'O felt pens

Encre à base d'eau

Water-based ink

Corps rond

Round body

Capuchon ventilé

Ventilated cap

Lavable

Washable



310952



FCG110092



310972



311952



FCG120092



311972

Réf FCG140092 & 312962

Pointe conique

Conic tip



FCG140092



312962

Modèle	Réf.	Conditionnement	UV	PCB
Model	Ref.	Packing		
Pointe fine / Fine tip				
12 pces	FCG110092	Pegboardable	20	120
36 pces	310952	Vrac / Bulk	1	36
144 pces	310972	Boîte / Box	1	8
Pointe moyenne-large / Medium-large tip				
12 pces	FCG120092	Pegboardable	24	96
36 pces	311952	Vrac / Bulk	1	36
144 pces	311972	Boîte / Box	1	8
Pointe extra-large / Jumbo tip				
10 pces	FCG140092	Pegboardable	12	72
70 pces	312962	Boîte / Box	1	8

Feutres BEROL / BEROL felt pens

Haute qualité
High quality



COLOURFINE = Pointe fine



COLOURBROAD = Pointe large



331234



331133



Modèle	Réf.	Conditionnement	UV	PCB
Model	Ref.	Packing		
Pointe fine / Colourfine				
12 pces	331233	Pochette / Pouch	1	100
42 pces	331234	Pot / Cup	1	24
Pointe large / Colourbroad				
12 pces	331133	Pochette / Pouch	1	100
42 pces	331134	Pot / Cup	1	24

Bâtons de couleur MIN'O / MIN'O crayon sticks

S'utilise sans eau
No water needed

Couleurs brillantes
Bright colours

Grand pouvoir couvrant
High covering power

Séchage rapide
Quick-drying



A base d'eau
Water-based



FCG510092

Gouache
en bâton

Effet métallisé
Metallic effect



656596



656306



FLUO



Modèle	Réf.	Conditionnement	UV	PCB
Model	Ref.	Packing		
12 pces	FCG510092	Pegboardable	12	48
96 pces	656596	Boîte / Box	1	4
Effet métallisé / Metallic effect				
6 pces	656306	Pegboardable	12	48
Fluo / Neon				
4 pces	656704	Pegboardable	12	96



Crayons de couleur / Coloured pencils

Crayons de couleur 18 cm
18 cm coloured pencils
12 couleurs assorties
12 assorted colours



FCG000393



FCG000293



FCG000192



FCG010092



FCG000092



Modèle	Réf.	Conditionnement	UV	PCB
Model	Ref.	Packing		
Pot de crayons de couleur 18 cm - 12 couleurs assorties / Box of coloured pencils 18 cm - 12 assorted colours				
48 pcs	FCG000293	Boîte / Box	1	36
"School pack" : Range crayons à compartiments 144 crayons de couleur 18 cm - 12 couleurs assorties / Box of 144 coloured pencils 18 cm - 12 assorted colours				
144 pcs	FCG000393	Boîte / Box	1	10

Modèle	Réf.	Conditionnement	UV	PCB
Model	Ref.	Packing		
Forme octogonale - Octogonal shape				
12 pcs	FCG000092	Pegboardable	24	144
18 pcs	FCG000192	Pegboardable	24	144
Forme triangulaire - Triangular shape				
12 pcs	FCG010092	Pegboardable	24	144

Crayons MIN'O pour écolier / MIN'O crayons

Crayons noirs « gros modules » aux multiples applications :

- > S'utilisent sur les ardoises effaçables à sec
- > Crayons noirs gras pour toutes surfaces lisses
- > Aquarellables pour les « artistes » en herbe

Jumbo multi-function crayons :

- > Can be used on dry-wipe boards
- > Crayon with soft lead for any smooth support
- > Watercolour for budding « artists »

18cm, mine Ø 8 mm et crayon Ø 11 mm
18 cm, lead Ø 8 mm and crayon Ø 11 mm

Mine grasse, haut pouvoir couvrant
Soft lead, high covering power

Taille-crayons
"gros modules"

Disponibles en
page 18 et 21.



370301



370301

Modèle	Réf.	Conditionnement	UV	PCB
Model	Ref.	Packing		
6 pcs	370301	Boîte / Box	1	120

▪ ECRITURE / WRITING

Crayons graphite / Graphite pencils



FEC100242



FEC100142



FEC100042

H	HB	B	2B
N°3	N°2	N°1	N°0



Modèle	Réf.	Conditionnement	UV	PCB
Model	Ref.	Packing		
Boîte de 12 crayons graphite / Box of 12 graphite pencils				
Qualité économique / Economic quality				
HB	FEC100042	Pegboardable	1	144
HB bout gomme	FEC100142	Pegboardable	1	144
Qualité standard / Standard quality				
HB	FEC100242	Pegboardable	1	144
2B	382336	Pegboardable	1	144
4 x HB	382518	Pegboardable	12	144

Aides à écrire / Pencil grips

Réf 989062

4,2 x 1,9 cm
4,2 x 1,9 cm



989011



989012

Modèle	Réf.	Conditionnement	UV	PCB
Model	Ref.	Packing		
Aides à écrire ergonomiques / Ergonomic pencil grips				
10 pces	989012	Vrac / Bulk	1	160
50 pces	989011	Boîte / Box	1	12
100 pces	989019	Vrac / Bulk	1	18



989062

Modèle	Réf.	Conditionnement	UV	PCB
Model	Ref.	Packing		
Aides à écrire triangulaires 4,2 x 1,9 cm / 4,2 x 1,9 cm triangular pencil grips				
6 pces	989062	Vrac / Bulk	1	120



Portemines / Mechanical pencils

- Corps plastique
Plastic body
- Embout gomme
Eraser tip
- Clip d'attache
With clip



FEC070062



Modèle Model	Réf. Ref.	Conditionnement Packing	UV	PCB
Lot de 10 portemines - Couleurs assorties / Set of 10 mechanical pencils - Assorted colours				
HB 0,7 mm	FEC070062	Pegboardable	12	144

Portemines « INNOVATIVE »

- Corps plastique avec grip antiglisse
Plastic body with soft rubber grip
- Embout gomme haute qualité
High quality eraser tip
- Amortisseur de mine
Damper
- Clip d'attache
With clip



900449



900450



900451



900452



900453



Portemines « PRO »

- Corps plastique et métal avec grip antiglisse
Plastic and metal body with soft rubber grip
- Embout gomme haute qualité
High quality eraser tip
- Amortisseur de mine
Damper
- Clip d'attache métal
With metal clip

Modèle Model	Réf. Ref.	Conditionnement Packing	UV	PCB
Portemines "Innovative" / « Innovative » mechanical pencils				
HB 0,5 mm	900449	Vrac / Bulk	12	1200
HB 0,7 mm	900450	Vrac / Bulk	12	1200
Portemines "Pro" / « Pro » mechanical pencils				
HB 0,5 mm	900451	Vrac / Bulk	12	1200
HB 0,7 mm	900452	Vrac / Bulk	12	1200
HB 0,9 mm	900453	Vrac / Bulk	12	1200

Mines de rechange pour portemines

/ Spare blades for mechanical pencils

- Étui de 12 mines
Case of 12 spare leads



900081



Modèle Model	Réf. Ref.	Conditionnement Packing	UV	PCB
Étui de 12 mines / Case of 12 spare leads				
HB 0,5 mm	900081	Vrac / Bulk	12	2880
HB 0,7 mm	900082	Vrac / Bulk	12	2880
HB 0,9 mm	900080	Vrac / Bulk	12	2880

Stylo-roller à cartouche d'encre standard

/ Roller ball pen with standard ink cartridge

133 mm

Pointe métal

Metal nib

Corps en PP

Body made in PP

Livré avec une cartouche d'encre bleue effaçable

Comes with one erasable blue ink cartridge



Présentoir de 36 pcs

36 pcs display box



395112 x 36 pcs

Modèle	Réf.	Conditionnement	UV	PCB
Model	Ref.	Packing		
133 mm	395112	Vrac / Bulk	36	864

Stylo-plume MIN'O / MIN'O fountain pen

133 mm

Pointe métal

Metal nib

Corps en PP

Body made in PP

Livré avec une cartouche d'encre bleue effaçable

Comes with one erasable blue ink cartridge



Présentoir de 36 pcs

36 pcs display box



397112 x 36 pcs

Modèle	Réf.	Conditionnement	UV	PCB
Model	Ref.	Packing		
133 mm	397112	Vrac / Bulk	36	864

Cartouches d'encre / ink cartridges

Cartouches standard

Short standard cartridges

Réf 398242

Encre effaçable bleue

Blue erasable ink



398242



398045

Modèle	Réf.	Conditionnement	UV	PCB
Model	Ref.	Packing		
Sachet de 30 cartouches / Pouch of 30 cartridges				
Bleu ■	398242	Pegbordable	12	240
Noir ■	398045	Pegbordable	12	240



Effaceurs-réécrivains / Ink eradicator pens



Effaceur pointe ogive
Bullet tip ink eradicator



Réécrivain pointe fine
Fine tip rewriter
Encre bleue
Blue ink



FEC310062



Modèle	Réf.	Conditionnement	UV	PCB
Model	Ref.	Packing		
Effaceurs-réécrivains / Ink eradicator pens				
6 pces	FEC310062	Pegboardable	12	96

Surligneurs / Highlighters

Coloris fluo
Neon colours



306012 x 10 pces

306022 x 10 pces

306042 x 10 pces

306032 x 10 pces



Pointe large biseautée
Large chisel tip
Trait de 2 à 5 mm
2 to 5 mm width



Modèle	Réf.	Conditionnement	UV	PCB
Model	Ref.	Packing		
Surligneurs / Highlighters				
Jaune / Yellow	306012	Vrac / Bulk	10	120
Vert / Green	306022	Vrac / Bulk	10	120
Rose / Pink	306032	Vrac / Bulk	10	120
Orange / Orange	306042	Vrac / Bulk	10	120
Lot de 4	306085	Pegboardable	12	144



Pointe biseautée
Chisel tip
Trait de 1 à 4 mm
1 to 4 mm width



307085



Modèle	Réf.	Conditionnement	UV	PCB
Model	Ref.	Packing		
Surligneurs corps fins / Narrow highlighters				
Lot de 4	307085	Pegboardable	12	144

▪ ACCESSOIRES D'ÉCOLE / SCHOOL ACCESSORIES

Trousses / Pencil cases

Plates fluo / Flat & neon

Format 11 x 22 cm

Size 11 x 22 cm

PVC

Made of PVC



804902

Couleurs assorties / Assorted colours

Modèle	Réf.	Conditionnement	UV	PCB
Model	Ref.	Packing		
11 x 22 cm	804902	Vrac / Bulk	12	96

Plates / Flat

Format 11 x 22 cm

Size 11 x 22 cm

En nylon

Made of nylon



804102

Couleurs assorties / Assorted colours

Modèle	Réf.	Conditionnement	UV	PCB
Model	Ref.	Packing		
Plate	804102	Vrac / Bulk	12	144

Rectangulaires avec 2 compartiments

/ Rectangular pencil case with double zipper

Format 22 x 9 x 6 cm

Size 22 x 9 x 6 cm

Tissu Oxford 600D

Made of 600D Oxford fabric



804502

Couleurs assorties / Assorted colours

Modèle	Réf.	Conditionnement	UV	PCB
Model	Ref.	Packing		
22 x 9 x 6 cm	804502	Vrac / Bulk	12	144

Rondes / Round

Format Ø 7 cm x 22 cm

Size Ø 7 cm x 22 cm

Tissu oxford

Made of oxford fabric



804002

Couleurs assorties / Assorted colours

Modèle	Réf.	Conditionnement	UV	PCB
Model	Ref.	Packing		
Ronde	804002	Vrac / Bulk	12	144



Mini trousse carrées / Mini square pencil cases

Format 20 x 3,5 x 3 cm
Size 20 x 3,5 x 3 cm

Simili cuir
Imitation leather



804802 par 24 pces



804802

FLUO



804812 par 24 pces

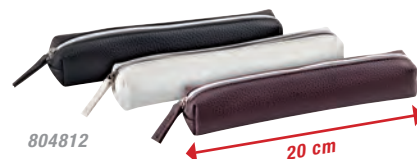

804812

20 cm

Couleurs assorties / Assorted colours

Modèle	Réf.	Conditionnement	UV	PCB
Model	Ref.	Packing		
Fluo	804802	Vrac / Bulk	24	96
Classique	804812	Vrac / Bulk	24	96

Tampons de notation "MOOD" / "MOOD" teacher stamps

Pré-encrés
Pre-inked
Non rechargeables
Non-refillable

REF. 580068

Environ 5000 impressions
Around 5,000 prints

3 couleurs d'encres
3 coloured inks



Ø 16 mm



580068



Ø 10 mm



580178

REF. 580178

Environ 4000 impressions
Around 4,000 prints

4 couleurs d'encres
4 coloured inks



Modèle	Réf.	Conditionnement	UV	PCB
Model	Ref.	Packing		
Ø 16 mm	580068	Pegboardable	12	48
Ø 10 mm	580178	Pegboardable	12	48

Étiquettes autocollantes / Self-adhesive labels

36 x 56 mm
36 x 56 mm

Planches de 4 étiquettes
Sheets of 4 labels

Coins arrondis
Rounded corners

x 240 étiquettes
x 240 labels



570012



570005



570015

Modèle	Réf.	Conditionnement	UV	PCB
Model	Ref.	Packing		
24 pces	570015	Pegboardable	24	480
240 pces	570012	Vrac / Bulk	6	120
24 pces	570005	Pegboardable	24	480

Gourdes aluminium
/ Aluminium bottle

500 ml
500 ml

Aluminium
Aluminium

Coloris assortis
Assorted colours

FAS100071



Modèle	Réf.	Conditionnement	UV	PCB
Model	Ref.	Packing		
500 ml	FAS100071	Vrac / Bulk	10	30

Siflet / Whistle

Métal
Metal

Avec cordon
With cord



FOP800071



Modèle	Réf.	Conditionnement	UV	PCB
Model	Ref.	Packing		
	FOP800071	Vrac / Bulk	12	240

Pièces et billets « EURO »
/ « EURO » coins and bank notes

Reproduction de pièces en plastique
et de billets euros
Reproduction of plastic euro coins and bank notes

Permet l'apprentissage par le jeu
de la monnaie euro

Allows game-based learning of euro currency



Modèle	Réf.	Conditionnement	UV	PCB
Model	Ref.	Packing		
Sachet de 80 pièces + 65 billets « Euro » / Pouch of 80 euro coins + 65 euro notes				
	989002	Vrac / Bulk	1	20
Sachet de 65 billets « Euro » / Pouch of 65 euro notes				
	989004	Vrac / Bulk	1	20
Sachet de 50 pièces « Euro » / Pouch of 50 euro coins				
	989005	Vrac / Bulk	1	50

Chronomètre / Stopwatch

Chronomètre digital étanche, précis au 1/100^{ème} de seconde
Waterproof 1/100th second digital stopwatch

Temps simple, temps au tour/temps intermédiaire
Normal time, split/lap time

Grand affichage
Large digits

Fonction horloge, calendrier et alarme
Time, calendar and alarm functions

Boussole et pile incluses
Compass and cell battery included



438004

Modèle	Réf.	Conditionnement	UV	PCB
Model	Ref.	Packing		
Digital	438004	Boîte / Box	1	144



Blouse Junior/ Junior size career apparel

Blouse blanche + cintre
White work coat + hanger

Tissu 100% coton 190 g/m²
100% cotton fabric 190 gsm

Fermeture par boutons en plastique
Closure by plastic buttons

Manches longues, col tailleur et 3 poches
Long sleeves, open collar and 3 pockets

Gamme complète page 95
Full range page 95



Modèle	Réf.	Conditionnement	UV	PCB
Model	Ref.	Packing		
Junior 8-10 ans	SEP250021	Vrac / Bulk	10	20

■ **CARTES GÉOGRAPHIQUES POUR ÉCOLIER**
PLASTIC MAPS FOR PUPILS



969015

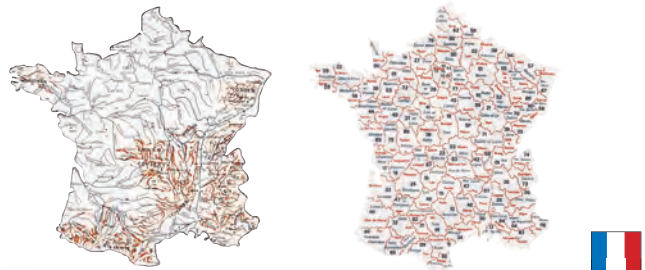

Modèle	Réf.	Conditionnement	UV	PCB
Model	Ref.	Packing		
2 Cartes de France superposables : administrative et géographique / 2 Superimposable maps of France : French subdivisions / French rivers and relief				
15 x 15 cm	969015	Sachet LS / Hanging Pouch	10	70

■ **FLÛTES / RECORDERS**

LA GAMME

Matière ABS
ABS material

Mode d'emploi
Instructions for use

Etui de rangement réutilisable
Reusable pouch



FOP800162

FOP800392

980186

Modèle	Réf.	Conditionnement	UV	PCB
Model	Ref.	Packing		
Flûte à bec YAMAHA Soprano				
Doigté baroque / Baroque Fingering				
■	FOP800162	Pegboardable	1	24
Doigté moderne / Modern Fingering				
■	FOP800262	Pegboardable	1	24
Couleurs transparentes / Transparent colours				
Doigté moderne / Modern Fingering				
■ ■ ■	FOP800392	Pegboardable	1	24
Flûte à bec "School Day" Soprano				
Doigté baroque / Baroque Fingering				
■	980186	Pegboardable	10	100

ACTIVITÉS MANUELLES ET CRÉATIVES / MANUAL AND CRAFTING ACTIVITIES

Craie de trottoir "marelle" / Jumbo chalk



FEC700293

Ø
25 mm



FEC700092



FEC700393



Modèle	Réf.	Conditionnement	UV	PCB
Model	Ref.	Packing		
Craies rondes / Rounded chalk				
●	FEC700092	Boîte de 6 / Box of 6	1	60
	FEC700293	Pot de 20 / Tub of 20	1	12
Craies triangulaires / Triangular chalk				
▲	FEC700192	Boîte de 8 / Box of 8	1	60
	FEC700393	Pot de 25 / Tub of 25	1	12

Carton mousse / Foam board

Carton mousse blanc / White foam board

Carton mousse avec une base de polystyrène recouvert sur les deux côtés avec du papier couché de 150g/m²

Foam board based on polystyrene covered on both sides with white coated paper 150g/m²

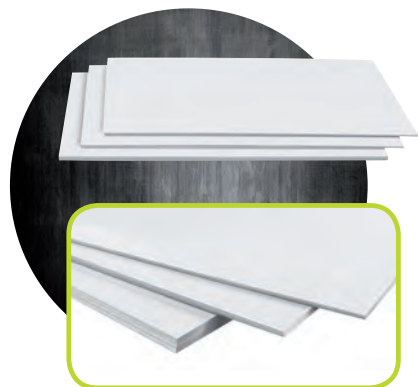

Modèle	Réf.	Conditionnement	UV	PCB
Model	Ref.	Packing		
Epaisseur 3 mm / 3 mm thickness				
21 x 29,7 cm	APP100061	Vrac / Bulk	80	80
29,7 x 42 cm	APP100161	Vrac / Bulk	40	40
50 x 65 cm	APP100261	Vrac / Bulk	40	40
Epaisseur 5 mm / 5 mm thickness				
21 x 29,7 cm	APP100361	Vrac / Bulk	50	50
29,7 x 42 cm	APP100461	Vrac / Bulk	25	25
50 x 65 cm	APP100561	Vrac / Bulk	25	25
Epaisseur 10 mm / 10 mm thickness				
21 x 29,7 cm	APP100661	Vrac / Bulk	30	30
29,7 x 42 cm	APP100761	Vrac / Bulk	15	15
50 x 65 cm	APP100861	Vrac / Bulk	15	15
70 x 100 cm	APP100961	Vrac / Bulk	15	15

Carton mousse noir / Black foam board

Carton mousse avec une base de polystyrène noir et recouvert sur les deux côtés de papier noir mat.

Foam board based on black polystyrene covered both sides with black mat paper.

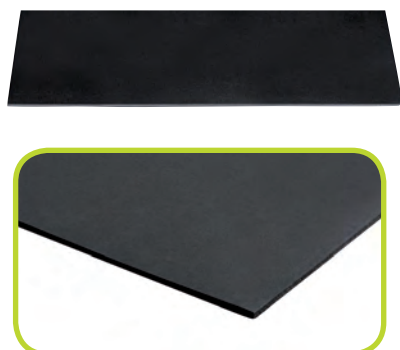

Produits non gencodés à l'unité

No barcode label on units



Modèle	Réf.	Conditionnement	UV	PCB
Model	Ref.	Packing		
Epaisseur 5 mm / 5 mm thickness				
21 x 29,7 cm	APP150061	Vrac / Bulk	50	50
29,7 x 42 cm	APP150161	Vrac / Bulk	25	25
50 x 65 cm	APP150261	Vrac / Bulk	25	25
70 x 100 cm	APP150361	Vrac / Bulk	25	25
Epaisseur 10 mm / 10 mm thickness				
21 x 29,7 cm	APP150461	Vrac / Bulk	30	30
29,7 x 42 cm	APP150561	Vrac / Bulk	15	15
50 x 65 cm	APP150661	Vrac / Bulk	15	15
70 x 100 cm	APP150761	Vrac / Bulk	15	15



Plastique Fou / Shrink-film sheets



669925



669085



Format 20 x 30 cm
Size : 20 x 30 cm

Matière rétractable
Shrinkable material

S'utilise pour créer des broches, des porte-clefs...
To be used to create brooches, key rings...

Modèle	Réf.	Conditionnement	UV	PCB
Model	Ref.	Packing		
Transparent / Sanded				
3 feuilles	669085	Pegboardable	10	50
7 feuilles	990028	Vrac / Bulk	1	50
25 feuilles	669032	Vrac / Bulk	1	25
Couleurs assorties / Assorted colours				
10 feuilles	669925	Pegboardable	10	50

Métal à repousser / Metal embossing sheets



661335



661935

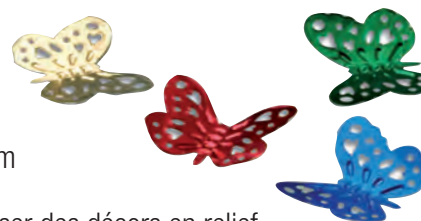

Format : 21 x 30 cm
Size : 21 x 30 cm

S'utilise pour réaliser des décors en relief
To be used to create decorations in relief

Feuilles métal 6/100^{ème} au verso couleur argent
Metal sheets 6/100 with silver backside

Modèle	Réf.	Conditionnement	UV	PCB
Model	Ref.	Packing		
1 Rouge - 1 Vert - 1 Bleu / 1 Red - 1 Green - 1 Blue				
3 feuilles / sheets	661335	Pegboardable	10	50
2 Or - 1 Cuivre / 2 Gold - 1 Copper				
3 feuilles / sheets	661935	Pegboardable	10	50
Or - Verso Argent / Silver backside				
10 feuilles / sheets	990047	Pegboardable	10	50

Papier carbone / Carbon paper



691925



APP000102

10 feuilles
10 sheets

Format A4
A4 size

Réf. APP000002 - Bleu - Pour écriture manuscrite
Blue - For handwriting

Réf. APP000102 - Noir - Pour machine à écrire
Black - For typewriter



Modèle	Réf.	Conditionnement	UV	PCB
Model	Ref.	Packing		
Bleu	APP000002	Pegboardable	12	144
Noir	APP000102	Pegboardable	12	144
Couleurs	691925	Pegboardable	12	144

Feuilles aimantées / Magnetic sheets

Réalise tes magnets !



660105



990117

Feuilles aimantées à décorer
Magnetic sheets to be decorated

Pour réaliser des magnets personnalisés
To make personalised magnets

S'utilise avec les perforateurs "Fantaisie"
et des feutres permanents

Ideal use with craft punchers, and permanent markers

Modèle	Réf.	Conditionnement	UV	PCB
Model	Ref.	Packing		
5 feuilles Pour imprimante jet d'encre / For inkjet printer	990117	Pegboardable	10	30
4 feuilles	660105	Pegboardable	10	50

Cartes à gratter / Scratchboards

Pochette de 10 cartes à gratter / Set of 10 scratchboards

10 cartes à gratter « arc-en-ciel »
Set of 10 « Scratch-it rainbow sheets »

+ 1 stylet en bambou
+ 1 bamboo scratch tool

+ 2 pochoirs en carton
+ 2 cardboard stencils

Dimensions : 114 x 153 mm
Size: 114 x 153 mm

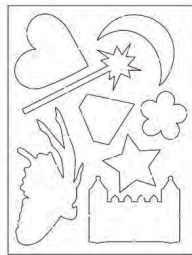
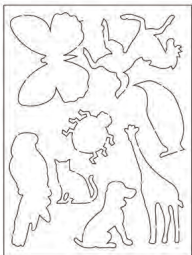

663045



Modèle	Réf.	Conditionnement	UV	PCB
Model	Ref.	Packing		
Arc-en-ciel / Rainbow 114 x 153 mm				
10 feuilles	663045	Pegboardable	12	144



Cube de 50 mini cartes à gratter / Set of 50 scratch-it mini cards

50 mini cartes à gratter
50 scratch-it mini cards
Dimensions : 89 x 89 mm
Size : 89 x 89 mm
+ 2 stylets bambou
+ 2 bamboo scratch tools



APP050102



APP050202

Modèle	Réf.	Conditionnement	UV	PCB
Model	Ref.	Packing		
50 mini cartes à gratter / 50 scratch-it mini cards				
Arc-en-ciel	APP050102	Vrac / Bulk	1	108
Holographique	APP050202	Vrac / Bulk	1	108

Cartes à gratter format A4 / A4 scratchboards

Lot de cartes à gratter au format A4
Set of A4 scratchboards
+ 1 stylet bambou à 2 embouts
+ 1 bamboo scratch tool "fine and large tips"

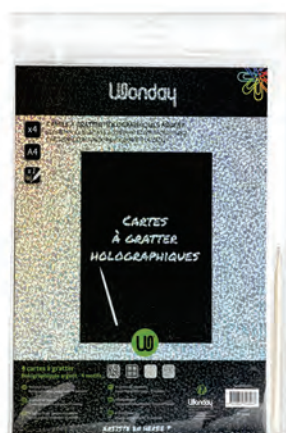

APP050092

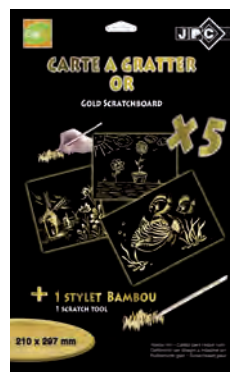

664335



664635



664035



664435



664825



Modèle	Réf.	Conditionnement	UV	PCB
Model	Ref.	Packing		
Cartes à gratter format A4 / A4 scratchboards				
5 feuilles / 5 sheets				
Arc-en-ciel	664035	Pegboardable	6	18
Or	664335	Pegboardable	6	18
Blanc	664435	Pegboardable	6	18
Argent	664635	Pegboardable	6	18
4 feuilles / 4 sheets				
Fluo	664825	Pegboardable	6	18
Holographique	APP050092	Pegboardable	6	18
Stylet bambou / Bamboo scratch tool				
10 pces	668002	Vrac / Bulk	1	10

■ GOMMETTES / STICKERS

Gommettes autocollantes / Stickers

Pochette format A5

A5 size

8 planches

8 sheets

Couleurs assorties

Assorted colours

Lot de 10 planches de gommettes formes et coloris assortis (couleurs et métallisées).

Set of 10 sheets of stickers (assorted colours and patterns).



Conditionnement Packing	UV	PCB
Pegboardable Header tag	10	50

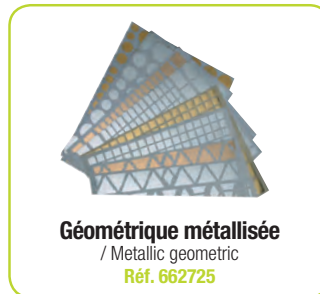

Papier spécial gommettes repositionnables

/ Special paper for repositionable coloured stickers

Se colle et se recolle !



983015

6 feuilles couleur A4 (21 x 29,7 cm)

6 A4 (21 x 29,7 cm) coloured sheets

Papier autocollant repositionnable

Repositionable self-adhesive paper

Support refendu en quadrillage 2 x 3 cm

Support ready-split in 2 x 3 cm cross-ruling

S'utilise avec les perfos fantaisie et ciseaux cranteurs

Ideal use with craft punches and craft scissors

Réf. Ref.	Conditionnement Packing	UV	PCB
983015	Sachet / Polybag	10	50



■ PEINTURE / PAINTING

12 pastilles de gouache / Box of 12 watercolour cakes



APN450191



APN450092

12 pastilles de gouache + 1 pinceau
Box of 12 watercolour cakes + 1 brush included



Modèle	Réf.	Conditionnement	UV	PCB
Model	Ref.	Packing		
Rectangle	APN450092	Pegboardable	12	72
Palette	APN450191	Vrac / Bulk	12	72

Gouache / Gouache paint



APN400192



APN400092

Tubes de 12 ml
12 ml tubes
Gouache épaisse
Couleurs denses
Haut pouvoir couvrant
Thick gouache for deep coloured
smooth and complete coverage



Modèle	Réf.	Conditionnement	UV	PCB
Model	Ref.	Packing		
5 x 12 ml	APN400092	Pegboardable	12	120
12 x 12 ml	APN400192	Pegboardable	12	60

Acrylique "Meltdown"



331404

331403

Peinture acrylique
Acrylic paint
Tous supports
Any support
Finition brillante
Brilliant finishing



Réf.	Taille	Couleur	UV	PCB
Ref.	Size	Colour	UV	
331403	250 ml	Or / Gold	1	6
331404	250 ml	Argent / Silver	1	6

Gouache concentrée

/ Concentrated gouache

Peut être diluée / Can be diluted

Facile à utiliser / Easy to use



655614

655609



Réf.	Taille	Couleur	UV	PCB
Ref.	Size	Colour	UV	PCB
655601	250 ml	Noir / Black	1	10
655609	250 ml	Blanc / White	1	10
655614	250 ml	Vert émeraude / Emerald green	1	10
655626	250 ml	Rouge vif / Sharp red	1	10
655632	250 ml	Bleu primaire / Primary blue	1	10
655636	250 ml	Rouge primaire / Primary red	1	10
655638	250 ml	Jaune primaire / Primary yellow	1	10

Gouache 1L / 1L gouache

Semi-épaisse

Creamy consistency



670932

670936

670938



Réf.	Taille	Couleur	UV	PCB
Ref.	Size	Colour	UV	PCB
670901	1000 ml	Noir / Black	1	12
670909	1000 ml	Blanc / White	1	12
670926	1000 ml	Vert moyen / Medium green	1	12
670932	1000 ml	Bleu primaire / Primary blue	1	12
670936	1000 ml	Rouge primaire / Primary red	1	12
670938	1000 ml	Jaune primaire / Primary yellow	1	12

ENCRES / INKS

Encres à dessiner

/ Drawing inks

A base d'eau, sans solvant
Solvent free water-based paint

Reprise au pinceau mouillé
très facile

Very easy touching up with
a moist paintbrush

Adaptée à tous les publics
Suitable for everybody



664602

664621



Réf.	Taille	Couleur	UV	PCB
Ref.	Size	Colour	UV	PCB
664601	250 ml	Noir / Black	1	10
664602	250 ml	Bleu cyan / Cyan blue	1	10
664605	250 ml	Orange / Orange	1	10
664606	250 ml	Rouge vermillon / Vermillion red	1	10
664610	250 ml	Violet / Purple	1	10
664613	250 ml	Terre de sienne / Raw sienna	1	10
664614	250 ml	Vert émeraude / Emerald green	1	10
664619	250 ml	Argent / Silver *	1	10
664621	250 ml	Rouge magenta / Magenta red	1	10
664638	250 ml	Jaune primaire / Primary yellow	1	10
664652	250 ml	Bleu outremer / Ultramarine	1	10
664658	250 ml	Or / Gold *	1	10
664664	250 ml	Vert printemps / Spring green	1	10
664668	250 ml	Jaune d'or / Golden yellow	1	10

* Prix de base différent

Encre de Chine

/ Indian ink

Extra noire

Extra black

Ton profond

Deep tone

Très couvrante

High covering power



669651



« Réalisation Charlie Lorey, artiste-peintre, Atelier Pinceau »



Réf.	Taille	Couleur	UV	PCB
Ref.	Size	Colour	UV	PCB
669551	100 ml	Encre de Chine / Indian ink	1	24
669651	250 ml	Encre de Chine / Indian ink	1	10



■ COLLES VINYLIQUES / VINYLIC GLUES

Colle vinylique / Vinylic glue

Colle blanche tous usages
Vinylic glue for all purposes

Colle la plupart des matériaux de loisirs et de bricolage : papier, carton, bois, mousse, feutrine, etc.
It can stick most materials used for do-it-yourself and craft activities : paper, cardboard, wood, foam, felt, etc.



665900



Réf.	Taille	Couleur	UV	PCB
Ref.	Size	Colour		
665600	250 ml	Colle vinylique en flacon / Vinylic glue in flask	1	10
665900	1000 ml	Colle vinylique en flacon / Vinylic glue in flask	1	12

Colle vinylique extra forte / Extra strong vinylic glue

Pour travaux manuels
For manual activities

Pour des collages solides de tous types de matériaux : papiers, cartons, bois, tissus, feutrines, etc.
For strong collage of all kinds of materials: paper, cardboard, wood, fabric, felt, etc.



669630



Réf.	Taille	Couleur	UV	PCB
Ref.	Size	Colour		
669630	250 ml	Colle forte super vinylique en flacon / Super vinylic strong glue in flask	1	10

Vernis colle concentré / Concentrated varnish glue

Medium de haute qualité autorisant toutes les activités de collage, d'apprêt et de vernis collage
High quality medium for all kinds of collage, primer and varnish-glueing activities

Résultat souple et brillant / Résistant à l'eau une fois sec
Brilliant and supple results / Water-resistant once dry

Diluable à l'eau jusqu'à 30% pour les activités où la fluidité est nécessaire
Thinning down with water up to 30% for activities requesting fluidity

S'incorpore aisément à toutes nos couleurs pour confectionner des produits tous supports et les protéger dans la masse
Easily blends with all our colours for making products of any support and protect them thoroughly and deeply



699800



Réf.	Taille	Couleur	UV	PCB
Ref.	Size	Colour		
699800	500 ml	Vernis colle concentré en flacon / Flask of concentrated varnish glue	1	10

Vernis colle technique serviettes / Varnish glue for napkins' technique

Economique et efficace
Economical and efficient

Finition satinée
Satin finishing

Consistance crémeuse et douce pour ne pas déchirer le papier
Creamy and soft consistency for preventing paper from getting torn up



669600



Réf.	Taille	Couleur	UV	PCB
Ref.	Size	Colour		
669600	250 ml	Vernis colle technique serviettes / Varnish glue for napkins' technique	1	10

Vernis colle vitrificateur / Vitrifying varnish glue

Protège en une ou deux couches
Protection in 1 or 2 coatings

Finition brillante
Brilliant finishing

Très résistant à l'eau, aux détergents et à l'abrasion
Highly water-resistant, detergent-resistant and abrasion-resistant



331304



Réf.	Taille	Couleur	UV	PCB
Ref.	Size	Colour		
331304	1 L	Vernis colle / Varnish glue	1	12

MATÉRIEL DE PEINTURE / PAINTING EQUIPMENT

Pot anti-verse / Non spill water pot

Hauteur : 87 mm
Height: 87 mm

Ø supérieur 75 mm et Ø inférieur 55 mm
75 mm upper Ø and 55 mm lower Ø

Composé de 3 parties pour faciliter le nettoyage
Made of 3 parts for an easy cleaning



APN900091



Modèle	Réf.	Conditionnement	UV	PCB
Model	Ref.	Packing		
	APN900091	Vrac / Bulk	6	24

Set de 3 godets mélangeurs gigognes + couvercle / Nest of 3 mixing pots + 1 lid

3 godets ronds à fond plat emboîtables
Nest of 3 flat-bottomed mixing pots

Ø 53 mm, Ø 49 mm et Ø 45 mm
Ø 53 mm, Ø 49 mm and Ø 45 mm

Livré avec un couvercle
Comes with one lid



689005



Réf.	Conditionnement	UV	PCB
Ref.	Packing		
689005	Pegboardable	12	240

Palettes / Palettes

Plastique blanc opaque
Opaque white plastic

Ref. APN900262
Palette ovale / Oval palette

Dimensions : 22 x 16 cm
Dimensions : 22 x 16 cm

Ref. APN900361
Palette rectangulaire / Rectangular palette

Dimensions : 23 x 13 cm
Dimensions : 23 x 13 cm



APN900262



APN900361



Modèle	Réf.	Conditionnement	UV	PCB
Model	Ref.	Packing		
Palette de peinture ovale / Oval painting palette				
22 x 16 cm	APN900262	Pegboardable	1	200
Palette de peinture rectangulaire / Rectangular painting palette				
23 x 13 cm	APN900361	Vrac / Bulk	10	100

Palette pelable / Tear-off palette

Format A4
A4 size

40 feuilles
40 sheets

90 gr/m²
90 gr/m²

Pour l'huile, l'acrylique et la gouache
For oil, acrylic and watercolour paint



688662

Modèle	Réf.	Conditionnement	UV	PCB
Model	Ref.	Packing		
40 feuilles	688662	Vrac / Bulk	10	40



Tabliers enfant / Kid aprons



APN500022

Manches longues resserrées
Long sleeves with tightened ends

Matière imperméable
Waterproof fabric

Lavable
Washable

Fermeture à scratch
dans le dos
Touch fastener on the back



APN550022

Tablier chasuble
enfant 5-8 ans
5-8 years chasuble

Matière imperméable
Waterproof fabric

Lavable
Washable

Poches devant
Pockets in the front



APN500122

Taille Size	Réf. Ref.	Conditionnement Packing	UV	PCB
■ Chasuble 5-8 ans / 5-8 years chasuble	APN550022	Pegboardable	1	100
■ 3-5 ans / 3-5 years	APN500022	Pegboardable	1	100
■ 5-8 ans / 5-8 years	APN500122	Pegboardable	1	100



Rouleaux à peindre mousse / Foam paint rollers

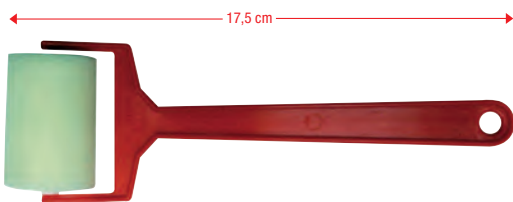

APN250061

Diamètre 30 mm
ø 30 mm



Modèle Model	Réf. Ref.	Conditionnement Packing	UV	PCB
Rouleau à peindre mousse / Foam paint rollers				
L. 45 mm	APN250061	Vrac / Bulk	6	576
L. 60 mm	983422	Vrac / Bulk	10	480

Pinceaux / Brushes

Lot de 10 pinceaux assortis
/ Set of 10 assorted brushes

Tailles et formes assorties
- 4 pinceaux ronds N° 0, 4, 6 et 8
- 4 pinceaux brosses N° 2, 4, 6 et 8
- 2 pinceaux arrondis N° 4 et 8

Assorted sizes and models
- 4 round brushes N° 0, 4, 6 et 8
- 4 flat brushes N° 2, 4, 6 et 8
- 2 filbert brushes N° 4 et 8

Virole aluminium
Aluminium ferrule

Poils synthétiques marron
Synthetic brown hair

Manche long en bois marron
Long brown wooden handle

Livré dans son étui de rangement en coton
Comes in a canvas holder



681995

Modèle Model	Réf. Ref.	Conditionnement Packing	UV	PCB
Lot de 10 pinceaux assortis / Set of 10 assorted brushes				
	681995	Vrac / Bulk	1	72

Pinceaux brosse / Flat brushes

Virole aluminium

Aluminium ferrule

Fibres synthétiques ocre jaune

Synthetic yellow hair

Manche court en bois rouge métallisé

Short metallic red wooden handle

Pour gouache et acrylique
Pour les fonds, les aplats
les traits épais...

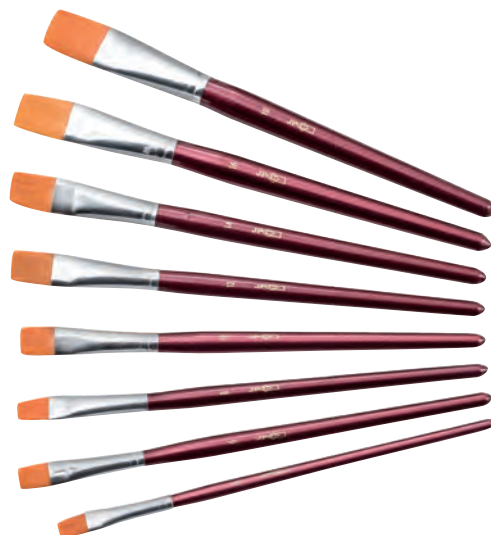

APN100842

Ref. APN100842

N° 6, 10 et 14

N° 6, 10 and 14

Modèle	Réf.	Conditionnement	UV	PCB
Model	Ref.	Packing		
Set de 3 pinceaux brosse / Set of 3 flat brushes				
3 pcs	APN100842	Pegboardable	12	240
Pinceau brosse poils synthétiques N° 4 / N° 4 flat brush synthetic hair				
N° 4	680122	Vrac / Bulk	10	60
Pinceau brosse poils synthétiques N° 6 / N° 6 flat brush synthetic hair				
N° 6	680132	Vrac / Bulk	10	60
Pinceau brosse poils synthétiques N° 8 / N° 8 flat brush synthetic hair				
N° 8	680142	Vrac / Bulk	10	60
Pinceau brosse poils synthétiques N° 10 / N° 10 flat brush synthetic hair				
N° 10	680152	Vrac / Bulk	10	60
Pinceau brosse poils synthétiques N° 12 / N° 12 flat brush synthetic hair				
N° 12	680162	Vrac / Bulk	10	60
Pinceau brosse poils synthétiques N° 14 / N° 14 flat brush synthetic hair				
N° 14	680172	Vrac / Bulk	10	60
Pinceau brosse poils synthétiques N° 16 / N° 16 flat brush synthetic hair				
N° 16	680182	Vrac / Bulk	10	60
Pinceau brosse poils synthétiques N° 18 / N° 18 flat brush synthetic hair				
N° 18	680502	Vrac / Bulk	10	60

Pinceaux ronds / Round brushes

Virole aluminium

Aluminium ferrule

Fibres synthétiques ocre jaune

Synthetic yellow hair

Manche court en bois bleu métallisé

Short metallic blue wooden handle

Pour gouache et acrylique
Pour les détails, les
finitions, les lignes...



APN200042

Ref. APN200042

N° 4, 8 et 12

N° 4, 8 and 12

Modèle	Réf.	Conditionnement	UV	PCB
Model	Ref.	Packing		
Set de 3 pinceaux ronds / Set of 3 round brushes				
3 pcs	APN200042	Pegboardable	12	240
Pinceau rond poils synthétiques N° 2 / N° 2 round brush synthetic hair				
N° 2	680012	Vrac / Bulk	10	60
Pinceau rond poils synthétiques N° 4 / N° 4 round brush synthetic hair				
N° 4	680022	Vrac / Bulk	10	60
Pinceau rond poils synthétiques N° 6 / N° 6 round brush synthetic hair				
N° 6	680032	Vrac / Bulk	10	60
Pinceau rond poils synthétiques N° 8 / N° 8 round brush synthetic hair				
N° 8	680042	Vrac / Bulk	10	60
Pinceau rond poils synthétiques N° 10 / N° 10 round brush synthetic hair				
N° 10	680052	Vrac / Bulk	10	60
Pinceau rond poils synthétiques N° 12 / N° 12 round brush synthetic hair				
N° 12	680062	Vrac / Bulk	10	60
Pinceau rond poils synthétiques N° 14 / N° 14 round brush synthetic hair				
N° 14	680072	Vrac / Bulk	10	60
Pinceau rond poils synthétiques N° 16 / N° 16 round brush synthetic hair				
N° 16	680082	Vrac / Bulk	10	60
Pinceau rond poils synthétiques N° 18 / N° 18 round brush synthetic hair				
N° 18	680402	Vrac / Bulk	10	60
Pinceau rond poils synthétiques N° 20 / N° 20 round brush synthetic hair				
N° 20	680412	Vrac / Bulk	10	60



TAMPONS / STAMPS

Boîte de tampons géants / Box of giant stamps



125011
Ferme
Farm

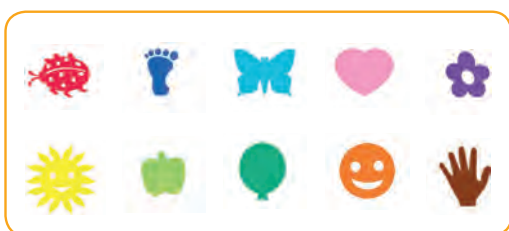

125021
Figuratifs
Figurative

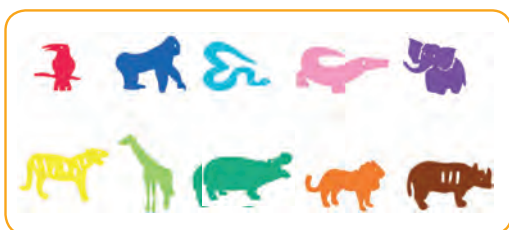

125031
Animaux sauvages
Wild animals

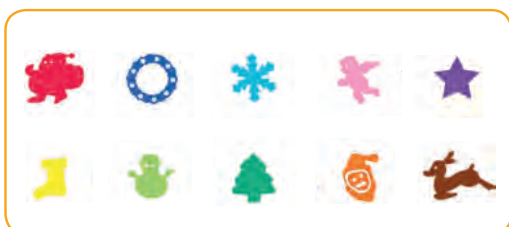

125041
Noël
Christmas

Poignée ergonomique antitache
No smear ergonomic handle

Mousse EVA compacte
EVA compact foam

Disque ø 75 mm
ø 75 mm disc

Sticker et repère indiquant le sens du motif
Sticker and up arrow showing the pattern direction

S'utilisent avec la gouache, l'encre gel et l'encre à dessiner
Can be used with gouache paint, glue ink and drawing ink

Can be used with gouache paint, glue ink and drawing ink

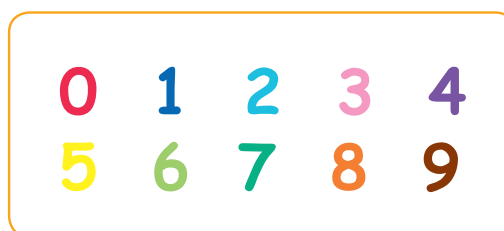

125051
Chiffres
Figures

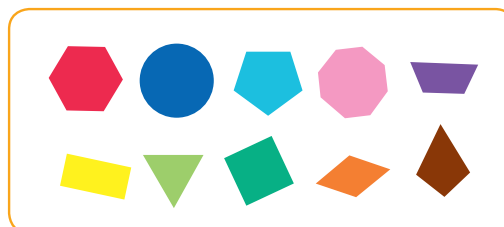

125061
Géométrique
Geometric



125001
Alphabet
Alphabet



Modèle / Model	Réf. / Ref.	Conditionnement / Packing	UV	PCB
Alphabet / Alphabet	125001	Boîte / Box	1	5

Modèle / Model	Réf. / Ref.	Conditionnement / Packing	UV	PCB
Ferme / Farm	125011	Boîte / Box	1	10
Figuratifs / Figurative	125021	Boîte / Box	1	10
Animaux sauvages / Wild animals	125031	Boîte / Box	1	10
Noël / Christmas	125041	Boîte / Box	1	10
Chiffres / Figures	125051	Boîte / Box	1	10
Géométriques / Geometric	125061	Boîte / Box	1	10

Tampons encres couleur

/ Coloured ink pads

∅ 9 cm

∅ 9 cm

Rechargeable avec de l'encre

Refillable with ink

Couleurs assorties

Assorted colours



Pour Tampons Géants
For Giant Stamps



035812

Réf.	Taille	Modèle	UV	PCB
Ref.	Size	Model		
035812	∅ 9 cm	Boîte de 12 tampons encres couleur (4 couleurs assorties)	1	6

Gels pailletés / Glitter glue

Forte concentration en paillettes

Strongly concentrated in glitter

Embout doseur

Measuring nozzled tube



983502

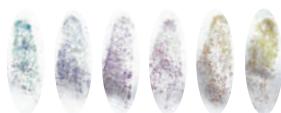

983518



983528

Modèle	Réf.	Conditionnement	UV	PCB
Model	Ref.	Packing		
Gel pailleté Pastel / Pastel coloured glitter glue				
	983518	Blistre / Blister	1	144
Gel pailleté Lumineux / Sharp coloured glitter glue				
	983528	Blistre / Blister	1	144
Boîte de 50 gels pailletés assortis / Box of 50 assorted glitter glue				
	983502	Boîte / Box	1	24



Embout de fil à plomb / Plumb bob

Laiton véritable
Solid brass
Longueur 32 mm / Diamètre 11 mm
Length 32 mm / 11 mm diameter
Poids 16 g
Weight 16 g
Vendu sans le fil
Comes without thread

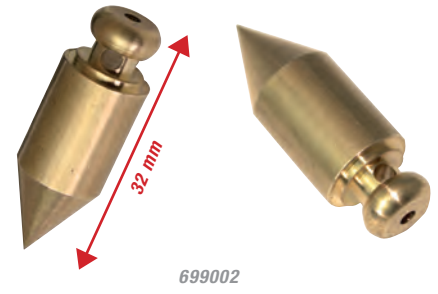

699002

Idéal pour le dessin d'observation.
Le fil à plomb permet de déterminer l'inclinaison
des objets par rapport à la verticale du fil.

Modèle Model	Réf. Ref.	Conditionnement Packing	UV	PCB
Ø 11 mm	699002	Vrac / Bulk	12	720

Tube à dessin plastique / Plastic document tube



APN900761

Pour le classement et le transport
For classification and transport
Plus résistant que les tubes carton
Higher hardwearing capacity than cardboard tubes



Modèle Model	Réf. Ref.	Conditionnement Packing	UV	PCB
ø 80 mm télescopique de 78 à 135 cm avec bandoulière / ø 80 mm expanding telescopic - 78 to 135 cm - with shoulder strap				
APN900761		Vrac / Bulk	1	12

Pinces pour travaux manuels / Pliers for craft hobbies

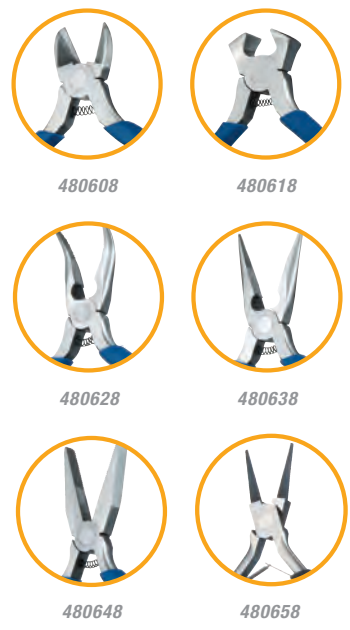

480462

Modèle Model	Réf. Ref.	Conditionnement Packing	UV	PCB
Pince coupante / Cutting pliers				
	480608	Pegboardable	6	120
Pince coupante 2 / Cutting pliers 2				
	480618	Pegboardable	6	120
Pince à bec courbe / Curved-nose pliers				
	480628	Pegboardable	6	120
Pince à bec droit / Straight-nose pliers				
	480638	Pegboardable	6	120
Pince plate / Flat pliers				
	480648	Pegboardable	6	120
Pince bec rond / Round-nose pliers				
	480658	Pegboardable	6	120
Pince à épiler / Chrome-plated tweezers				
8,5 cm	480462	Vrac / Bulk	12	600

■ CISEAUX ET ACCESSOIRES DE COUPE / SCISSORS AND CUTTING ACCESSORIES

Ciseaux cranteurs pour travaux manuels, pour personnaliser et créer un décor !

Craft scissors for handicraft : personalise and create your own decorations !

Ciseaux cranteurs - 13 cm / Kid Craft scissors - 13 cm

Lames inox protégées
Stainless steel protected blades
Ne coupent que le papier
Cut paper only



ADE010063

Modèle	Réf.	Conditionnement	UV	PCB
Model	Ref.	Packing		
Lot de 6 cranteurs 13 cm / Wallet of 6-13 cm craft scissors				
ADE010063		Vrac / Bulk	1	36

Ciseaux cranteurs - 16 cm / Craft scissors - 16 cm

Lames inox protégées
Stainless steel protected blades



275852

Modèle	Réf.	Conditionnement	UV	PCB
Model	Ref.	Packing		
Grandes vagues / Big waves				
	275144	Pegboardable	6	60
Petites vagues / Small waves				
	275154	Pegboardable	6	60
Zig Zag / Zig Zag				
	275164	Pegboardable	6	60
Créneau zipper / Zipper				
	275174	Pegboardable	6	60
Parchemin / Parchment				
	275184	Pegboardable	6	60
Arabesque / Arabesque				
	275194	Pegboardable	6	60
Lot de 6 cranteurs 16 cm / Wallet of 6-16 cm craft scissors				
	275102	Vrac / Bulk	1	36
Lot de 12 cranteurs 16 cm / Wallet of 12-16 cm craft scissors				
	275852	Vrac / Bulk	1	24

Ciseaux et cutter de précision

/ Precision scissors and cutter

Inox 11,5 cm
Stainless steel 11,5 cm
Pointe fine pour travaux de précision
Fine point for accurate work



271908

Entièrement métallique / 140 mm
Made of metal only / 140 mm

Cutter de précision + étui 2 lames
Precision cutter + case of 2 spare blades



BCU400272

Réf.	Conditionnement	UV	PCB
Ref.	Packing		
271908	Pegboardable	12	120

Réf.	Conditionnement	UV	PCB
Ref.	Packing		
BCU400272	Pegboardable	12	120



Rogneuse Trimm'up et accessoires / Trimm'up paper trimmer and accessories



405028

Livré avec 8 cassettes de lames
Comes with 8 cassettes of spare blades

Pour activités manuelles et scolaires,
Manual and school activities

Facile à manipuler
Easy to handle

Sécurité maximale
Extra safe

Format A4 - A3
A4 - A3 size

S'utilisent avec des cassettes de lames :
8 formes de coupe au choix
Used with cassettes of spare blades :
8 available cutting shapes



406048

Cassette de lame pour massicot Trimm'up
Cassette of spare blade for Trimm'up paper trimmer

8 formes de coupe au choix
8 available cutting shapes

Modèle Model	Réf. Ref.	Conditionnement Packing	UV	PCB
Massicot Trimm'up PACK-8 lames / Trimm'up Pack-8 paper trimmer	405028	Pegboardable	1	30
Petite vague / Wave	406028	Pegboardable	1	240
Zig-zag / Pinking	406038	Pegboardable	1	240
Double ligne / Scoring  PLIAGE	406048	Pegboardable	1	240
Grande vague / Scallop	406058	Pegboardable	1	240
Dune / Rhythm	406068	Pegboardable	1	240
Victorien / Victorian	406078	Pegboardable	1	240
Pointillé / Perforating	406088	Pegboardable	1	240

■ PERFORATEURS "LONG BRAS" / DECORATIVE LONG ARM PUNCHERS











Des perfos spécialement étudiés pour perforer au milieu de la feuille.
Système de rotation du motif pour l'incliner suivant vos envies.

Decorative punchers specially designed to punch in the middle of the sheet.
Rotative pattern so as to tilt it the way you want.

Taille réelle / Real size
14 mm



986004

 Feuille / Maple leaf Réf. 986004	 Ours / Bear Réf. 986014	 Fleur / Flower Réf. 986054	 Dauphin / Dalphin Réf. 986074	 Soleil / Sun Réf. 986084
 Chat / Cat Réf. 986094	 Pied / Foot Réf. 986104	 Ange / Angel Réf. 986114	 Rond ø 6 mm / Circle ø 6 mm Réf. 987904**	 Rond ø 3 mm / Circle ø 3 mm Réf. 987914**

** Perforateur non rotatif / None rotary puncher

Condit. Packing	UV	PCB
Blister / Blister	1	60

PERFORATEURS / DECORATIVE PUNCHERS

Mini XS



XS

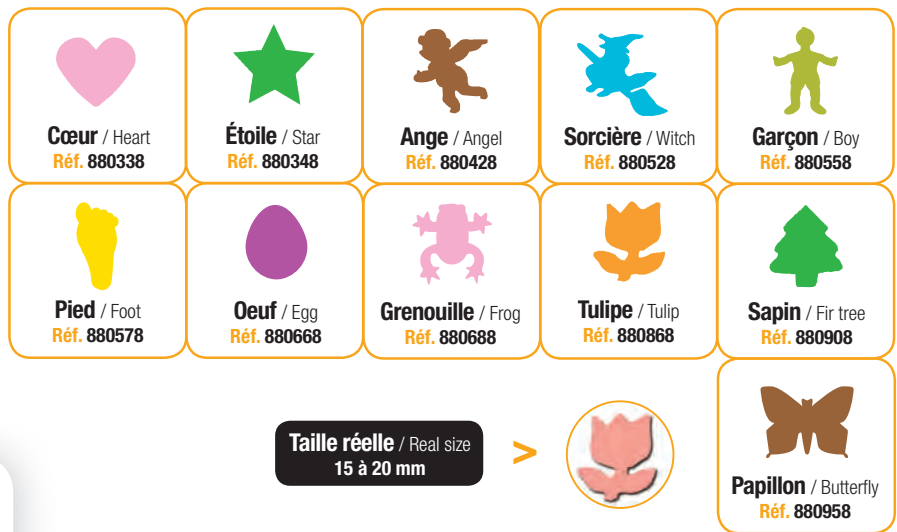

Taille réelle / Real size
15 à 20 mm



Condit.	UV	PCB
Packing		
Blisters / Blisters	2	192

Medium S

12 pcs par présentoir
12 pcs per display
4 modèles assortis
4 assorted patterns



000040



000041

Réf.	Conditionnement	UV	PCB
Réf.	Packing		
000040	Présentoir / Display	1	10
000041	Présentoir / Display	1	10



S



^

Taille réelle / Real size
20 à 25 mm



Condit.	UV	PCB
Packing		
Blisters / Blisters	2	96



JUMBO L



L

 Cœur / Heart Réf. 885334	 Étoile / Star Réf. 885344	 Ours / Bear Réf. 885414
 Cercle / Circle Réf. 885624	 Palmier / Palm Réf. 885734	 Sapin / Fir tree Réf. 885904
 Papillon / Butterfly Réf. 885954		



Taille réelle / Real size
50 à 55 mm

Condit. / Packing	UV	PCB
Blisters / Blisters	1	36

JUMBO XXL



XXL

 Feuille / Maple leaf Réf. 887404
--



Taille réelle / Real size
70 à 75 mm

Condit. / Packing	UV	PCB
Blisters / Blisters	1	18

PERFORATEURS - EMBOSEURS / DECORATIVE PUNCHERS - CRAFT EMBOSSERS

Pour un meilleur rendu nous conseillons l'utilisation de papier 80-180 gr
For best results : use 80-180 gr craft paper



 Cœurs entrelacés / Interlinked hearts Réf. 888064

Condit. / Packing	UV	PCB
Blisters / Blisters	1	18

PCB
36



Taille réelle / Real size
45 à 50 mm

PERFORATEURS "PETIT MODÈLE" / DECORATIVE SMALL PUNCHERS

Motifs interchangeables : les cassettes « Croq'motifs » s'insèrent dans la pince « Croq'perfo » et sont interchangeables pour réaliser de multiples découpes

«Croq'motifs» inserts fit into the «Croq'perfo» craft handle and are interchangeable.

Croq' Perfo : pince unique / Croq'perfo : single craft handle



984904

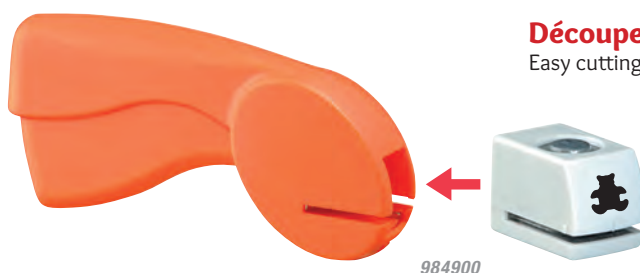

984900

Découpe facile même pour les plus petits !

Easy cutting even for the youngest children !

Grammage maximum 100g

Grammage up to 100g















984700

Modèle Model	Réf. Ref.	Conditionnement Packing	UV	PCB
Pince / Craft handle	984900	Vrac / Bulk	1	96
Pince / Craft handle	984904	Pegboardable	2	8
Lot pince + 4 motifs	984700	Vrac / Bulk	1	-

Croq' Motifs : motifs multiples / Craft inserts : several patterns insert



984300

 Pomme / Apple Réf. 984318	 Cœur / Heart Réf. 984338	 Étoile / Star Réf. 984348	 Soleil / Sun Réf. 984388	 Rond / Circle Réf. 984408
 Ours / Bear Réf. 984418	 Ballon / Balloon Réf. 984428	 Spirale / Spiral Réf. 984438	 Feuille / Maple leaf Réf. 984458	 Pied / Foot Réf. 984478
 Chat / Cat Réf. 984488	 Dauphin / Dolphin Réf. 984498	 Éléphant / Elephant Réf. 984978		

Taille réelle / Real size
10 mm



Condit. Packing	UV	PCB
Vrac / Bulk	2	288



PERFORATEURS "COINS" / DECORATIVE CORNER PUNCHERS

Perfos coins multi-motifs médium M Medium M multi-pattern corner punchers



Taille réelle / Real size
40 à 45 mm



Condit.	UV	PCB
Packing		
Blister / Blister	1	48

Perfos coins médium M / Medium M corner punchers



888824



Taille réelle / Real size
30 à 35 mm

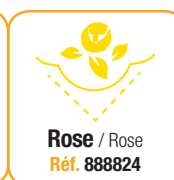
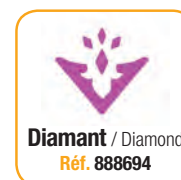

Condit.	UV	PCB
Packing		
Blister / Blister	1	72

PERFORATEURS "BORDURE" / DECORATIVE BORDER PUNCHERS

Perfos « bordure » à levier / Lever « border » punchers



889868



Taille réelle / Real size
35 à 40 mm



Condit.	UV	PCB
Packing		
Blister / Blister	1	72

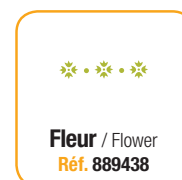

Perfos « bordure continue » / Edge continuous punching set

Taille réelle / Real size
50 x 25 mm

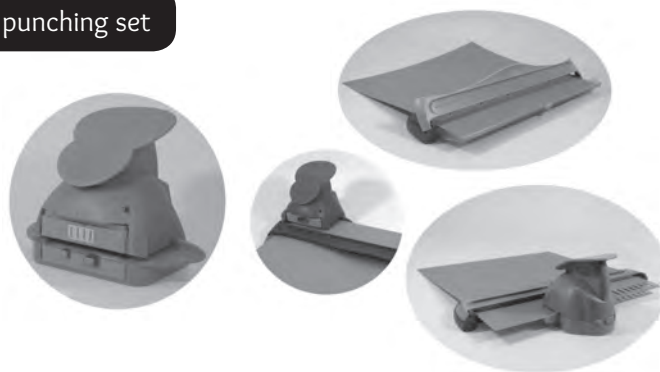

Set de 3 pièces :
Perforateur à levier
"Règle"
+ 1 cassette fleur



Cassette de rechange pour
perfo bordure continue Réf. 889908



Modèle Model	Réf. Ref.	Conditionnement Packing	UV	PCB
Set 3 pcs	889908	Blister / Blister	1	12

Condit. Packing	UV	PCB
Blister / Blister	1	72



A	
Accessoires électriques	89
Adhésifs	36 à 38
Adhésifs couleur	36
Affûtoir	18
Agrafes	32
Agrafeuse électrique	32
Agrafeuses	28 à 32
Aides à écrire	112
Aimants	42
Anneaux brisés	44
Ardoises	100, 105 & 106
Ardoises blanches	106
Ardoises éducatives	100
Ardoises naturelles	105
Ardoises noires plastique et carton	106
Armoires à clefs	91
Articles à tableau	62 à 63 & 102
Attaches	40 à 44
Attaches adhésives "trou européen"	92
Attaches papillon	42
Attaches parisiennes	41
B	
Badge rigide	84 & 85
Badges	84 & 85
Baguette télescopique	69
Bandes aimantées	42
Bâtons de couleur	110
Billets EURO	118
Blouses blanches	95 & 119
Boîtes à outils	94
Boîtiers éponge	104
Boussoles	88
Bouteilles d'encre	80
Bracelets caoutchouc	45
Brosses	102
C	
Cache-Clés	90
Cadenas	93
Caisses à monnaie	91
Cartes à gratter	122 à 123
Cartes géographiques pour écolier	119
Carton mousse	120
Cartouches d'encre	114
Chemises à rabat	73
Chevalet de conférence	67
Chevalet porte-nom	85
Chronomètre	118
Ciseaux	8 à 17
Ciseaux cranteurs	17 & 134
Ciseaux de précision	134
Colle vinylique	127
Colles	46
Coloriage	109 à 112
Compas	48 à 51
Compas scolaires	48 à 50
Compas techniques	51
Cordons à mousqueton	85
Correcteurs	46 à 47
Correcteurs liquide	46
Correcteurs liquide à base d'eau	46
Craies	103
Craies de trottoir	120
Crayons blancs pour ardoises	104
Crayons de couleur	111
Crayons graphite	112
Croq'Motif	138
Croq'Perfo	138
Cutter de précision	26 & 134
Cutters	24 à 26
D	
Dateurs	80
Décamètres	65
Dévidoir à poignée	39
Dévidoirs	38 à 39

Dévidoirs de notes repositionnables	77
Distributeurs de clip	33
Distributeurs magnétiques de trombones	40
Doigtiers hérissés	44
Double-décimètres	52 à 59
E - F - G	
Echelles de réduction	61
Écriture	112 à 115
Educ'ardoises	100
Effaceurs-réécrivains	115
Embout de fil à plomb	133
Encre de Chine	126
Encres à dessiner	126
Eponges	92
Equerre-rapporteurs	60
Equerres	52 à 63
Étiquettes autocollantes	117
Feuilles aimantées	122
Feutres	109 à 110
Flûtes	119
Gants	94
Gels paillés	132
Globes	96 à 99
Godets mélangeurs	128
Gomme mie de pain	108
Gommes	107 à 108
Gommettes	124
Gourdes aluminium	118
Grattoirs	86
L - M - N - O	
Lames pour cutters	25 à 26
Lavettes "micro-fibres"	92
Loupes	82 à 83
Loupes éclairantes	83
Machines à tailler	22
Marque-pages repositionnables	78 à 79
Marque-pages semi-rigides	78
Marqueur textile	95
Marqueurs à craie liquide	104
Marqueurs effaçables à sec	68
Métal à repousser	121
Mètres à ruban	65
Mines de rechange pour compas	50
Mines de rechange pour portemines	113
Mini balance de précision	87
Mini-brosses	105
Mouilleur de bureau	80
Multi-cases	82
Nettoyant pour tableaux blancs	68 & 103
Notes repositionnables	77 à 79
Numéroteur	80
Ôte-agrapes	33
Ouvre-lettres	86
P	
Palette	128
Palette pelable	128
Panneaux collectifs	101
Papier carbone	73 & 121
Papier carbone couleur	121
Parasurtenseurs	89
Pâte adhésive	37
Peintures	125 à 126
Pendules murales	94
Perforateurs	34 à 35
Perforateurs Bordure	139 à 140
Perforateurs Coins	139
Perforateurs Fantaisie	135 à 140
Perforateurs Long bras	135
Perforateurs-Embosseurs	137
Pèse-colis	87
Pèse-lettres	87
Pièces EURO	118
Pince à dégrafer	33
Pince à épiler	133
Pince-agrapes	31

Pinceaux	129 à 130
Pinces à dessin	43 à 44
Pinces pour travaux manuels	133
Pistolets à dessin	60
Planisphères	96
Plaques de coupe	27
Plastique fou	121
Pochette étanche pour smartphone	90
Pochettes à scratch	74 à 75
Pochettes coin à fenêtre	72
Pochettes perforées	72
Pochettes zippées	74
Pointeurs laser	69
Porte-blocs à pince	70 à 72
Porte-cartes de visite	74
Porte-craie	103
Porte-étiquettes	90
Porte-marqueurs magnétique	68
Porte-mines	113
Porte-tampons	80
Pot anti-verse	128
Pots à crayons	81
Protège-documents	73
Punaises	42
R	
Range-ciseaux	13 & 14
Rapporteurs	52 à 63
Recommandés avec AR (liasses et listing)	86
Règle en bois	62 à 63
Règles	52 à 63
Règles de coupe	27 & 60
Réglets	64
Relieurs d'archives	76
Rogneuse Trimm'up	135
Rollers de colle	46
Rouleaux à peindre	129
Rubans correcteurs	47
S	
Sacs navettes courrier	86
Scellés plastique	86
Scratch auto-agrippant	40
Sifflet	118
Socles pour éphémérides	81
Stylo-gomme	108
Stylo-plume	114
Stylo-roller	114
Surligneurs	115
T	
Tableaux adhésifs en rouleau	69
Tableaux blancs magnétiques	67
Tableaux en liège	66
Tabliers enfants	129
Taille-crayons	18 à 23
Taille-crayons électriques	23
Tampons de notation	117
Tampons encreurs	80
Tampons encreurs couleur	132
Tampons géants	131
Tés	62 à 63
Thermomètres	65
Traçage à mémoire de forme	52
Traçage à tableau	62 à 63
Traçage métal	58 à 59 & 64
Traçage plastique	52 à 61
Traçage plastique incassable	52 à 56
Trace-cercles	61
Triple-décimètres	52 à 59
Trombones	40 à 41
Trousse	116 à 117
Tubes à dessin plastique	133
V	
Vernis colle	127



20 cm rulers with handle	52 to 59
30 cm rulers with handle	52 to 59
3-flap folders	73

A - B

Adhesive hanging tags with euro hole	92
Aluminium bottles	118
Archiving binders	76
Badges	84 & 85
Bags with touch fastener	74 to 75
Binder clips	43 to 44
Blackboard drawing instruments	62 to 63
Blackboard instruments	62 to 63 & 102
Board wall stickers	69
Brushes	129 to 130
Business card holders	74
Butterfly paper clips	42

C

Carbon paper	73 & 121
Carton sealer	39
Cash boxes	91
Chalk	103
Chalk holder	103
Chalk markers	104
Circle templates	61
Clipboards	70 to 72
Clips	40 to 44
Collective panels	101
Coloured carbon paper	121
Coloured inking pads	132
Coloured packing tape	36
Coloured pencils	111
Colouring activities	109 to 112
Compasses	88
Compasses	48 à 51
Cords with snap hook	85
Cork boards	66
Correction fluids	46
Correction tapes	47
Correction tapes and fluids	46 to 47
Craft scissors	17 & 134
Crayon sticks	110
Croq'motif : Craft inserts	138
Croq'Perfo : Single craft handle	138
Cutters	24 to 26
Cutting mats	27
Cutting rulers	27 & 60

D

Date stamps	80
Decimeters	65
Decorative border punchers	139 to 140
Decorative corner punchers	139
Decorative long arm punchers	135
Decorative punchers	135 to 140
Decorative punchers - Craft embossers	137
Desk calendar bases	81
Desk organisers	82
Desk top sharpeners	22
Display books	73
Drawing inks	126
Dry-erase whiteboards	106
Drywipe boards "Educ'Ardoises"	100
Drywipe markers	68

E

Educational drywipe boards	100
Electric sharpeners	23
Electric stapler	32
Electrical accessories	89
Erasers	107 to 108
Erasers (For boards)	102
Erasing knives	86
EURO coins	118
EURO notes	118

F - G

Fabric marker	95
Fastening clips	41
Felt-tip pens	109 to 110
Flexible rulers	64
Flipchart	67
Foam boards	120
Foam paint rollers	129
Fountain pen	114
French curves	60
Giant stampers	131
Glitter glue	132
Globes	96 to 99
Gloves	94
Glue	46
Glue tapes	46
Graphite pencils	112

H - I - J - K

Highlighters	115
Illuminated magnifiers	83
Indian ink	126
Individual plastic and carboard blackboards	106
Individual writing boards	100, 105 & 106
Ink bottles	80
Ink cartridges	114
Ink eradicator pens	115
Inking pads	80
Jumbo Chalk	120
Key boxes	91
Keys caps	90
Kids aprons	129
Kneadable erasers	108

L - M - N - P

Label rings	90
Laser telescopic pointers	69
Letter openers	86
Letter scales	87
Loose-leaf rings	44
Magnetic adhesive strips	42
Magnetic paper clip dispensers	40
Magnetic pen holder	68
Magnetic precision tool set	94
Magnetic sheets	122
Magnetic white boards	67
Magnets	42
Magnifiers	82 to 83
Measuring tapes	65
Mechanical eraser	108
Mechanical pencils	113
Mechanical telescopic pointer	69
Memory shape drawing instruments	52
Metal drawing instruments	58 to 59 & 64
Microfiber dish cloths	92
Mini brushes	105
Mixing pots	128
Natural slate blackboards	105
Non spill water pot	128
Number stamp	80
Package scale	87
Padlocks	93
Paint palette	128
Paints	125 to 126
Paper clippers	33
Paper clips	40 to 41
Pencil cases	116 to 117
Pencil cups	81
Pencil grips	112
Planisphere	96
Plastic document tubes	133
Plastic drawing instruments	52 to 61
Plastic maps	119
Plastic seals	86
Pliers for craft hobbies	133
Plier-staplers	31

Plumb bob	133
Pocket precision scale	87
Postal bags	86
Precision cutter	26 & 134
Precision scissors	134
Protractors	52 to 63
Protractor-square sets	60
Punched pockets	72
Punches	34 to 35
Push pins	42

R - S

Recorders	119
Reduction scales	61
Relief foils	121
Removable page markers	78 to 79
Rigid badge	84 & 85
Roller ball pen	114
Rolling sticky notes	77
Rubber bands	45
Rulers	52 to 63
School compasses	48 to 50
Scissors	8 to 17
Scissors classpack	13 & 14
Scratchboards	122 to 123
Self-adhesives labels	117
Self-gripping hook and loop tape	40
Semi-rigid page-markers	78
Sharpeners	18 to 23
Shatterproof drawing instruments	52 to 56
Shrink-film	121
Spare blades for cutters	25 to 26
Spare leads for compasses	50
Spare leads for mechanical pencils	113
Sponge damper pad	80
Sponges	92
Sponges in individual box	104
Square sets	52 to 63
Stamp racks	80
Staple removers	33
Staplers	28 to 32
Staples	32
Stickers	124
Sticky notes	77 to 79
Stopwatch	118
Surge protector	89

T

Table name badges	85
Tack glue dots	37
Tape	36 to 38
Tape dispensers	38 to 39
Teacher stamps	117
Tear-off palettes	128
Technical compasses	51
Thermometers	65
Thimblettes	44
Trimmer	135
T-rulers	62 to 63
Tweezers	133

V - W - Z

Varnish glue	127
Vinyl glue	127
Wall clocks	94
Water-based correction fluids	46
Waterproof case for smartphone	90
Whistle	118
White pencils for blackboards	104
White work coat	95 & 119
Whiteboard cleaner	68 & 103
Window folders	72
Wooden ruler	62 to 63
Wooden sharpener	18
Writing	112 to 115
Zipper bags	74

INDEX NUMÉRIQUE / NUMERICAL INDEX



000013	53	271908	134	398242	114	531751	82	664606	126	804502	116	890042	71
000040	136	275102	17 & 134	401022	24	531901	82	664610	126	804802	117	890052	70
000041	136	275144	134	401508	25	535011	83	664613	126	804812	117	890062	70
000042	8	275154	134	402918	25	535458	82	664614	126	804902	116	890072	70
000043	40	275164	134	403142	25	535608	82	664619	126	807382	81	890402	70
000044	93	275174	134	403968	26	535761	83	664621	126	809102	81	891012	75
000061	52	275184	134	405028	135	535911	83	664635	123	809302	81	891702	75
000090	75	275194	134	406028	135	570005	117	664638	126	809312	81	891712	75
000982	58	275852	17 & 134	406038	135	570012	117	664652	126	809322	81	891722	75
005332	82	289214	10	406048	135	570015	117	664658	126	809352	81	891732	75
026922	13	289234	10	406058	135	571005	79	664664	126	809372	81	891742	75
035812	132	289254	10	406068	135	571015	79	664668	126	809382	81	891752	75
100218	28	300002	104	406078	135	571115	79	664825	123	809858	68	891762	75
100401	31	302085	68	406088	135	571205	79	665600	127	809951	81	891772	75
100501	31	306012	115	408118	26	571215	79	665900	127	830102	92	891782	75
100901	31	306022	115	408318	26	571315	79	668002	123	850912	22	891792	75
101001	29	306032	115	409028	26	571505	78	669032	121	850922	22	891802	75
102001	29	306042	115	409068	26	572005	77	669085	121	851102	18	891812	75
103011	30	306085	115	422012	86	572015	77	669095	37	851152	18	891822	75
103021	30	307085	115	422015	86	572025	77	669551	126	851202	18	891832	75
105401	34	309018	95	438001	94	572505	77	669600	127	853042	18	891842	75
105531	35	310952	109	438002	94	580068	117	669630	127	853252	20	900004	72
107711	31	310972	109	438004	118	580178	117	669651	126	854102	18	900021	90
117151	32	311952	109	459102	45	581032	86	669925	121	854108	18	900022	90
120119	105	311972	109	459122	45	581035	86	670901	126	854202	18	900046	39
120212	105	312962	109	459132	45	582032	86	670909	126	854208	18	900050	94
120312	105	331133	110	459805	45	583040	85	670926	126	856202	19	900080	113
120410	105	331134	110	464412	96	583460	84	670932	126	856212	19	900081	113
120612	105	331233	110	464912	96	583958	84	670936	126	856232	19	900082	113
120712	105	331234	110	472012	108	583970	84	670938	126	858611	39	900107	77
122012	106	331304	127	472102	108	583978	84	680012	130	859012	18	900108	77
122022	106	331403	125	472128	107	584901	80	680022	130	880338	136	900109	77
122112	106	331404	125	472212	107	585122	80	680032	130	880348	136	900119	93
122142	106	340005	46	474212	107	586401	80	680042	130	880428	136	900137	94
124012	106	340105	46	474218	107	587501	80	680052	130	880528	136	900138	94
124122	106	342112	46	474412	107	609231	87	680062	130	880558	136	900139	94
125001	131	342122	46	476212	107	610001	87	680072	130	880578	136	900154	78
125011	131	342142	46	476218	107	610111	87	680082	130	880668	136	900155	78
125021	131	345402	37	476312	107	610531	87	680122	130	880688	136	900156	78
125031	131	348502	47	477012	108	615001	87	680132	130	880868	136	900157	78
125041	131	349305	47	478412	108	630035	89	680142	130	880908	136	900158	78
125051	131	349502	47	479202	108	630055	89	680152	130	880958	136	900159	78
125061	131	350415	51	480462	133	633095	89	680162	130	881118	136	900160	78
126302	100	351238	48	480608	133	633195	89	680172	130	881158	136	900175	77
126312	100	351305	48	480618	133	634095	89	680182	130	881318	136	900176	77
126322	100	351635	48	480628	133	634195	89	680402	130	881338	136	900238	94
126332	100	352105	50	480638	133	635005	89	680412	130	881348	136	900260	84
129518	80	352215	49	480648	133	635105	89	680502	130	881358	136	900310	74
153612	63	352435	49	480658	133	635205	89	681995	129	881388	136	900311	86
159032	92	353005	50	500055	64	655601	126	688662	128	881398	136	900312	86
159042	92	353115	49	502022	64	655609	126	689005	128	881408	136	900313	86
159052	92	353435	49	502025	64	655614	126	691925	121	881418	136	900337	86
159102	92	355115	49	502032	64	655626	126	699002	133	881428	136	900351	86
163010	66	358005	51	502035	64	655632	126	699800	127	881438	136	900449	113
163110	66	361002	103	502052	64	655636	126	740254	41	881498	136	900450	113
169102	69	367001	104	502055	64	655638	126	741302	41	881518	136	900451	113
169202	69	367235	104	502152	64	656306	110	749251	44	881538	136	900452	113
169302	69	367335	104	502155	64	656596	110	750101	33	881868	136	900453	113
170018	88	368101	103	503032	64	656704	110	750202	40	881908	136	900459	38
170028	88	368131	103	503035	64	660105	122	750911	33	881938	136	900469	76
170041	88	368201	103	503052	64	661335	121	750921	33	881958	136	900471	76
170045	88	368211	103	503055	64	661935	121	757142	44	885334	137	900472	76
170111	88	368221	103	503102	64	662005	124	758322	43	885344	137	900802	72
170121	88	368231	103	503152	64	662015	124	759192	43	885414	137	900808	73
195038	93	368241	103	503202	64	662025	124	766201	40	885624	137	900811	73
195048	93	368261	103	504055	64	662035	124	766211	40	885734	137	900900	69
195128	93	369101	103	506001	61	662045	124	766221	40	885904	137	900901	69
195192	93	369131	103	506011	61	662055	124	766231	40	885954	137	900902	69
195408	93	369201	103	506021	61	662705	124	767012	90	887404	137	900906	85
195418	93	369211	103	506031	61	662715	124	767022	90	888064	137	910225	58
195428	93	369221	103	506041	61	662725	124	767042	90	888214	139	910245	58
195438	93	369231	103	506051	61	662735	124	767062	90	888694	139	910325	58
195504	93	369241	103	507012	65	662745	124	801302	81	888824	139	910345	58
195514	93	369261	103	507032	65	663045	122	801322	81	889438	139	910445	58
260212	16	370301	111	507052	65	664035	123	801352	81	889908	140	910545	58
260214	16	382336	112	507082	65	664335	123	801372	81	889918	140	910645	58
263100	17	382518	112	509132	65	664435	123	803012	81	889928	140	912245	59
268304	15	395112	114	509232	65	664601	126	803052	81	889938	140	912345	59
268352	16	397112	114	531501	82	664602	126	804002	116	889948	140	912445	59
268522	13	398045	114	531601	82	664605	126	804102	116	890022	70	912545	59

INDEX NUMÉRIQUE / NUMERICAL INDEX

913415	59	APN500122	129	FAF080173	32	FCI210282	9	FEL200103	45	FPP100192	79	FTS040162	55
913615	59	APN550022	129	FAF100073	32	FCI210482	9	FEL200202	45	FSC001013	69	FTS200062	56
913715	59	APN900091	128	FAF100173	32	FCI210862	9	FEL200303	45	FSC100083	66	FTS200162	54
913908	59	APN900262	128	FAF230273	32	FCI210961	11	FEL200402	45	FSC100183	66	FTS20062	56
914145	58	APN900361	128	FAF240073	32	FCI211061	11	FEL200503	45	FSC100283	66	FTS220162	54
916145	58	APN900761	133	FAF240173	32	FCI211162	11	FFI000073	42	FSC200073	67	FTS300062	56
917245	58	APP000002	73 & 121	FAF260073	32	FCI211261	11	FFI000293	42	FSC200173	67	FTS300162	54
927102	62	APP000102	73 & 121	FAF260173	32	FCI211362	11	FFI000493	42	FSC200273	67	FTS330062	56
931225	52	APP050092	123	FAG080082	31	FCI211452	11	FFI000592	42	FSC400073	67	FTS330162	54
931325	52	APP050102	123	FAG100162	28	FCI230082	10	FFI000672	42	FSC600041	102	FTS400062	56
931345	52	APP050202	123	FAG100272	28	FCI900063	14	FFI000772	42	FSC600141	102	FTS400162	54
931415	52	APP100061	120	FAG100362	29	FCI900283	13	FFI000872	42	FSC600261	102	FTS500062	56
931435	52	APP100161	120	FAG100482	31	FCM100061	74	FFI000892	42	FSC650062	68 & 102	FTS500162	54
931455	52	APP100261	120	FAG240082	29	FCM100161	74	FFI010292	42	FSC650162	102	FTS700062	56
931545	52	APP100361	120	FAG240382	31	FCM100261	74	FFI020072	44	FSC650361	102	FTS700162	56
931615	52	APP100461	120	FAG240563	32	FCM100361	74	FFI020272	44	FSC700022	102	FTS700262	55 & 54
931635	52	APP100561	120	FAG300073	30	FCM100461	74	FFI020373	44	FSC900031	68 & 103	FTS700362	55
931655	52	APP100661	120	FAI090102	42	FCM100561	74	FFI020472	44	FTA000041	63	FTS750062	56
931705	52	APP100761	120	FAI090202	42	FCM200061	74	FFI020573	44	FTA000141	63	FTS750162	56
931805	52	APP100861	120	FAI150092	42	FCM200161	75	FFI020672	44	FTA000261	63	FTS750262	55
958212	62	APP100961	120	FAI200092	42	FCM200261	75	FFI050572	41	FTA010041	62	FTS750362	55 & 54
962022	101	APP150061	120	FAI300092	42	FCM200361	75	FFI050672	41	FTA100041	63	FTS750462	55
962032	101	APP150161	120	FAI300792	42	FCM400061	73	FFI050772	41	FTA200041	63	FTS850062	56
962042	101	APP150261	120	FAI400092	42	FCM400161	73	FFI050872	41	FTA250041	63	FTS850162	55 & 54
963012	101	APP150361	120	FAI701111	42	FCM400261	73	FFI100073	42	FTA250141	63	FTS900063	54
963102	96	APP150461	120	FAR090192	104	FCM400361	73	FFI100272	42	FTA300061	63	FTT000271	27 & 60
965145	60	APP150561	120	FAR100041	105	FCO100063	48	FFI100373	42	FTA600041	63	FTT800271	27 & 60
969015	119	APP150661	120	FAR300162	106	FCO100272	48	FIM000062	65	FTA610041	62	FTT400271	27 & 60
980186	119	APP150761	120	FAR400162	106	FCO200073	49	FIM000162	65	FTA800041	63	FTT500271	27 & 60
983015	124	APQ010061	27	FAR900091	104	FCO300172	50	FL0100102	83	FTA800161	63	FTT600271	27 & 60
983422	129	APQ020061	27	FAR900291	104	FCO900062	50	FOP500063	96	FTA810041	62	FTT700362	60
983502	132	APQ030061	27	FAR900442	105	FCR040092	47	FOP550263	97	FTB250073	41	FTT800271	27 & 60
983518	132	APQ100061	27	FAR900542	105	FCR080002	47	FOP550363	98	FTB250173	41	FTT870272	62
983528	132	APQ200061	27	FAS100071	118	FCR080102	47	FOP550463	98	FTB250593	41	FTT870372	62
984318	138	APQ300061	27	FCG000092	111	FCR200021	46	FOP550563	98	FTB250772	41	FZZ100162	86
984338	138	APQ400061	27	FCG000192	111	FDB100061	14	FOP550663	98	FTB250892	41	GAD100011	36
984348	138	B 7520.05	89	FCG000293	111	FEC070062	113	FOP550763	98	FTB250992	41	GAD200011	36
984388	138	BCU090062	24	FCG000393	111	FEC100042	112	FOP550863	98	FTB300472	41	GAD200111	36
984408	138	BCU090162	24	FCG010092	111	FEC100142	112	FOP550963	99	FTB320073	41	GAD300011	36
984418	138	BCU090282	24	FCG110092	109	FEC100242	112	FOP551063	99	FTB320173	41	GAD300111	36
984428	138	BCU180062	25	FCG120092	109	FEC310062	115	FOP551163	99	FTB320593	41	GAD400011	36
984438	138	BCU180182	25	FCG140092	109	FEC700092	120	FOP551263	99	FTB320672	41	GAD400111	36
984458	138	BCU300082	25	FCG510092	110	FEC700192	120	FOP551363	99	FTB320693	41	GAD400211	36
984478	138	BCU400272	134	FCI100061	17	FEC700293	120	FOP551463	97	FTB500073	41	GAD400311	36
984488	138	BCU400372	26	FCI100161	17	FEC700393	120	FOP800071	118	FTB500192	41	GAD900063	39
984498	138	BLC090072	26	FCI120061	14	FEL000092	45	FOP800162	119	FTB770073	41	GAD900263	39
984700	138	BLC090171	26	FCI120162	14	FEL000193	45	FOP800262	119	FTB900062	40	GEX000003	44
984900	138	BLC180171	26	FCI120251	14	FEL000292	45	FOP800392	119	FTC100461	18	GEX100003	44
984904	138	BLC180272	26	FCI120352	14	FEL000392	45	FOTO10061	33	FTC100563	18	GEX110003	44
984978	138	BLC400072	26	FCI120462	17	FEL040002	45	FOTO10162	33	FTC150063	23	GEX120003	44
986004	135	BRE200072	64	FCI130081	15	FEL040103	45	FOTO20072	33	FTC150163	23	GID100162	84
986014	135	BRE300072	64	FCI130181	13	FEL060002	45	FPE010072	34	FTC250371	20	GID200061	84
986054	135	BRE310072	64	FCI130182	13	FEL060103	45	FPE020072	35	FTC250461	20	GID300061	84
986074	135	FA62100	91	FCI130281	15	FEL070002	45	FPE020172	34	FTC250571	20	GID300262	84
986084	135	FA62111	91	FCI130282	15	FEL070103	45	FPE020273	34	FTC250863	21	GID400061	85
986094	135	FA62120	91	FCI130352	13	FEL080002	45	FPE040072	35	FTC350063	21	GID400181	85
986104	135	FA62122	91	FCI130961	16	FEL080103	45	FPI000073	44	FTC500071	22	GID900021	85
986114	135	FA62133	91	FCI150182	8	FEL090002	45	FPI000172	44	FTC500171	22	GPB040171	71
987904	135	FA62137	91	FCI150382	13	FEL090103	45	FPI040172	44	FTE400062	57	GPB040261	71
987914	135	FA62162	91	FCI150452	13	FEL100002	45	FPI190172	43	FTE160093	53	GPB040361	70
989002	118	FA62170	90	FCI150561	14	FEL100103	45	FPI190273	43	FTE200062	57	GPB040441	71
989004	118	FA62171	91	FCI150662	14	FEL100202	45	FPI190372	43	FTE220062	57	GPB140061	70
989005	118	FA62202	91	FCI160082	9	FEL100303	45	FPI200073	43	FTE300062	57	GPB240061	72
989011	112	FA62207	91	FCI170182	8	FEL110002	45	FPI200172	43	FTE330062	57	GPN100062	90
989012	112	FAB100041	81	FCI170382	9	FEL110103	45	FPI250073	43	FTE400062	57	SEP250021	95 & 119
989019	112	FAB200001	81	FCI170562	9	FEL120002	45	FPI250172	43	FTE500062	57	SEP400021	95
989022	104	FAB200101	81	FCI170662	10	FEL120103	45	FPI300172	43	FTE700062	57	SEP410021	95
989062	112	FAB200201	81	FCI170761	11	FEL120202	45	FPI320073	43	FTE700162	57	SEP420021	95
990028	121	FAB200401	81	FCI170861	11	FEL120303	45	FPI320172	43	FTE750062	57	SEP430021	95
990047	121	FAB200601	81	FCI170962	11	FEL150002	45	FPI410073	43	FTE750162	57	SEP440021	95
990117	122	FAD100011	37	FCI171061	11	FEL150103	45	FPI410172	43	FTE850062	57		
ADE010063	17 & 134	FAD100111	37	FCI171162	11	FEL150202	45	FPI500073	43	FTE860062	57		
APN100842	130	FAD900062	38	FCI171252	11	FEL150303	45	FPI500172	43	FTN050062	60		
APN200042	130	FAD900191	38	FCI171571	12	FEL150402	45	FPI510073	43	FTP200001	80		
APN250061	129	FAD900261	38	FCI171671	12	FEL150503	45	FPI510172	43	FTP200201	80		
APN400092	125	FAD900363	38	FCI171772	12	FEL180002	45	FPI600073	43	FTP300033	80		
APN400192	125	FAD900463	38	FCI180182	8	FEL180103	45	FPI600172	43	FTP300133	80		
APN450092	125	FAD900563	38	FCI200071	12	FEL180202	45	FPI700073	43	FTP300233	80		
APN450191	125	FAD950062	38	FCI200171	12	FEL180303	45	FPI700172	43	FTS040062	56		
APN500022	129	FAF080073	32	FCI210182	8	FEL200002	45	FPP100092	77				



A series of horizontal lines for writing notes, spanning the width of the page.

Wonday[®]

creative tools for school and business





Crédit photo : Getty images - Catalogue imprimé en UE

JPC Créations

Parc d'activités «Entre Dore et Allier»
BP50 - allée des Frênes
63190 LEZOUX - France

Tél. +33 (0)4 73 61 20 68 - Fax. +33 (0)4 73 61 22 94
jpc@jpccreations.com - www.jpccreations.com